

OPTI PROD 2026



OFFRE VALABLE
JUSQU'AU 31.12.2026*

* Techmo Satech se réserve le droit de modifier les prix promotionnels en fonction des éventuels changements de prix de nos partenaires.

Carburier, Porte-outils et plaquette



Fraise carbure - HSS CO



Foret HSS + CW, Alésoir



Accessoire Machine outil



Attachement, Centre, Tour, Etaux



Métrologie



Divers



Franco de port départ agences - 150 €

Forfait expédition usine - 20 €

Pour toute expédition directe les frais de port seront facturés.

Les articles lourds sont indiqués par un logo poids. Pour ces articles, des frais de transport supplémentaires sont appliqués.



En stock



Délais
48/72 h



Sur
commande

UTILISATION DU COMPTE CLIENT SUR NOTRE SITE INTERNET

www.techmo.fr



www.satech.fr



Accueil | Créer un compte | Me connecter | Actualités



[NOS PRODUITS](#) |

Accueil | Mon compte | Actualités



[NOS PRODUITS](#) |

Vos informations de connexion

Nom de connexion | IDENTIFIANTS
Adresse courriel | ADRESSE E-MAIL RATTACHÉE AU COMPTE

***POSSIBILITÉ DE CHANGER LE MOT DE PASSE APRÈS CRÉATION DU COMPTE SI CELUI-CI EST OUVERT PAR NOS SOINS**

Modifier

Vos paniers mémorisés

Page 1 sur 1 | Aucune donnée

Nom du panier

Aucune donnée disponible ...

Vos commandes en cours

No document	Ref Client	Date
CV2023009306	CDE	4 oct. 2023
CV2023006329	CDE	4 juil. 2023
CV2023001714	CDE TEL	21 févr. 2023
CV2022010091	CDE	26 oct. 2022
CV2022008153	CDE TEL	8 sept. 2022
CV2022007914	CDE	1 sept. 2022

Vos devis en cours

No document	Ref Client	Date
DV2023006794		6 sept. 2023
DV2023006504		25 août 2023
DV2023005094		22 juin 2023
DV2023004711		9 juin 2023
DV2022006488		12 sept. 2022

Vos commandes archivées

No document	Ref Client	Date
CV2023009306	CDE	4 oct. 2023
CV2023009306	CDE	4 oct. 2023
CV2023006329	CDE TEL	4 juil. 2023
CV2023006329	CDE	3 juil. 2023
CV2023006329	CDE TEL	28 juin 2023



VOTRE RECHERCHE : Code article Techmo-Satech

ou Désignation ou REF fournisseur

Rechercher par code article TECHMO/SATECH
(Exemple : 366095)

Rechercher par désignation article ou
référence fournisseur (Exemple : CNMG120408) →
puis choisir le fournisseur souhaité

ou CNMG120408

Fournisseurs disponibles:

- EINES CANELA S.L. [850080]
- KENAMETAL-HERTEL FRANCE SA [956700]
- KORLOY EUROPE GmbH [850103]
- MITSUBISHI CARBIDE [973700]
- SCHWARZ GmbH Vollhartmetall Präzisions [850133]
- SUMITOMO [993340]
- TUNGALOY FRANCE S.A.S. [995100]

MÉMO

IDENTIFIANT :

LOGIN :



FRAISAGE

FRAISES POKOLM	6
FRAISES CARBURE	9
FRAISES HSS	28
FRAISES À CHANFREINER	29
FRAISES SCIÉS	31

PERÇAGE

FORETS CARBURE	35
FORETS HSS HSS CO	43
FORETS FRITTÉS	44
FORETS À PLAQUETTES FORETS À POINTER	45

TARAUDAGE

TARAUDS MACHINE VERGNANO	46
TARAUDS MACHINE BASS	49
BRAS DE TARAUDAGE ÉLECTRIQUE	53

TOURNAGE

PORTE-OUTILS INTÉRIEUR EXTÉRIEUR	54
PLAQUETTES FRAISAGE FILETAGE TOURNAGE	61

DIVERS | MACHINES

AFFÛTEUSE DE FORETS	65
COLONNES DE MESURE	65
STATION DE FRETTAGE	66
MACHINES TRADITIONNELLES	67

ATTACHEMENTS

PINCES	68
MANDRINS HYDRAULIQUES	72
MANDRINS PORTE-PINCES PORTE-FRAISES	73
MANDRINS WELDON	77
MANDRINS DE FRETTAGE	79
ATTACHEMENT SCHUNK	81
ATTACHEMENT COOLCAP	82
FILTRES POUR MACHINES	84

PRISE PIÈCES

ÉTAUX MÉTRIQUES ÉTAUX DE PRÉCISION	85
KIT ACCESSOIRES TOURNEVIS	87

ABRASIF

BROSSES EXPANSIBLES	89
MACHINE DE MARQUAGE	91
PLATEAU À DÉPRESSION	91
OUTILS DE BROCHAGE	93
PORTE-OUTILS VDI	94
TAMPONS ET BAGUES	97

FRAISES À COPIER | SPINWORX

SPINWORX®



- Utilisation à 100 % de l'arête de coupe totale
- Temps d'installation minimisés puisqu'aucune indexation manuelle des inserts n'est nécessaire
- Le volume de copeaux est beaucoup plus élevé sans interruption du processus de production
- Convient pour l'usinage de l'acier, de la fonte, de l'acier inoxydable et des superalliages résistants à la chaleur
- Idéal pour l'ébauche et l'usinage de la matière résiduelle lors du surfaçage, du rainurage, du fraisage périphérique et de poche
- Faible consommation d'énergie de la broche de la machine grâce à la formation de copeaux



Matière	INCONEL 718	Matière	TA 6 V	Matière	40 CMD 8	Matière	35 NCD16
Fraise	DR12-032-E-16-04	Fraise	DR12-050-A22-07	Fraise	DR10-025-E12-04	Fraise	DR16-080-A27-07
Diamètre nominal	32mm	Diamètre nominal	50 mm	Diamètre nominal	25 mm	Diamètre nominal	80 mm
Attachement	SK 40	Attachement	SK 40	Attachement	BT 40	Attachement	SK50
Porte à faux	85 mm	Porte à faux	approx. 100 mm	Porte à faux	approx. 80 mm	Porte à faux	165mm
Lubrification	Huile soluble à 10%	Lubrification	Huile soluble à 8%	Lubrification	Air centre broche	Lubrification	Air centre broche
Plaquette	DR12 8 B7	Plaquette	DR12-8B7	Plaquette	DR10 8 F4	Plaquette	DR16 8 F4
Vc	45 m/min	Vc	50m/min	Vc	180 m/min	Vc	200 m/min
N	448 tr /min	N	318 tr/min	N	2291tr/min	N	796 min-1
Fz	0,2mm/dt	Fz	0,19mm/dt	Fz	0,5 mm/dt	Fz	1 mm
Vf	358mm/min	Vf	423 mm/min	Vf	4584 mm/min	Vf	5570 mm/min
Ap	1mm	Ap	1,7mm	Ap	0,7 mm	Ap	2,5 mm
Ae	16mm	Ae	35 mm	Ae	15 mm	Ae	32 mm
Durée de vie	3,6 h	Durée de vie	10 h	Durée de vie	8,2 h	Durée de vie	11,3 h
Volume copeaux	5,73 cm³/min	Volume copeaux	29,63 cm³/min	Volume copeaux	48,13 cm³/min	Volume copeaux	445,63 cm³ /min

r3.5 - D 16 - 35 mm

Désignation	d1	d	r	l3	l2	d2	d3	z	Prix tarif € net HT
DR07-016-E08-02	16	7	3,5	28,5	1,2	M 8	13,8	2	193,96
DR07-020-E10-05	20	7	3,5	28,5	1,2	M 10	18,0	5	293,99
DR07-025-E12-06	25	7	3,5	28,5	1,2	M 12	21,0	6	317,12
DR07-030-E12-07	30	7	3,5	28,5	1,2	M 12	21,0	7	351,26
DR07-035-E16-08	35	7	3,5	28,5	1,2	M 16	29,0	8	385,40
DR07-8B7									19,42
DR07-8C4									15,93
DR07-8F4									15,93

r5 - D 20 - 52 mm

Désignation	d1	d	r	l3	l2	d2	d3	z	Prix tarif € net HT
DR10-025-E12-03	25	10	5	32,5	1,5	M 12	21,0	3	214,68
DR10-025-E12-04	25	10	5	32,5	1,5	M 12	21,0	4	248,83
DR10-032-E16-04	32	10	5	43,0	2,5	M 16	29,0	4	300,10
DR10-032-E16-05	32	10	5	43,0	2,5	M 16	29,0	5	323,22
DR10-035-E16-05	35	10	5	43,0	2,5	M 16	29,0	5	328,13
DR10-035-E16-06	35	10	5	43,0	2,5	M 16	29,0	6	373,30
DR10-8B7									20,51
DR10-8C4									16,80
DR10-8F4									16,80

r6 - D 24 - 100 mm

Désignation	d1	d	r	l3	l2	d2	d3	z	Prix tarif € net HT
DR12-032-E16-04	32	12	6	42,5	2,8	M 16	29,0	4	290,28
DR12-035-E16-05	35	12	6	42,5	2,8	M 16	29,0	5	328,13
DR12-040-A16-06	40	12	6	42,5	2,8	16	35,0	6	364,68
DR12-042-A16-05	42	12	6	42,5	2,8	16	35,0	5	333,04
DR12-050-A22-06	50	12	6	52,5	2,8	22	40,0	6	412,24
DR12-050-A22-07	50	12	6	52,5	2,8	22	40,0	7	447,69
DR12-052-A22-06	52	12	6	52,5	2,8	22	40,0	6	412,24
DR12-052-A22-07	52	12	6	52,5	2,8	22	40,0	7	447,69
DR12-8B7									21,71
DR12-8C4									18,33
DR12-8F4									18,33

r8 - D 32 - 125 mm

Désignation	d1	d	r	l3	l2	d2	d3	z	Prix tarif € net HT
DR16-052-A22-06	52	16	8	53,0	2,5	22	40,0	6	448,89
DR16-063-A27-06	63	16	8	53,0	2,5	27	48,0	6	494,06
DR16-066-A27-06	66	16	8	53,0	2,5	27	48,0	6	494,06
DR16-080-A27-07	80	16	8	53,0	2,5	27	60,0	7	589,18
DR16-100-A32-08	100	16	8	63,0	2,5	32	70,0	8	714,74
DR16-125-A40-09	125	16	8	53,0	2,8	40	90,0	9	1012,44
DR16-8B7									28,96
DR16-8C4									20,62
DR16-8F4									20,62

B7 - INOX, TITANE
C4 - ACIER (P25)
F4 - ACIER (P40)

SLOTWORX® VF

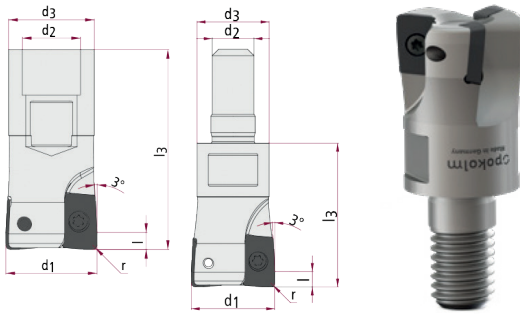

La nouvelle SLOTWORX® VF est une fraise spécialement conçue pour la finition. Grâce à la géométrie spéciale de la plaquette indexable, l'outil peut être utilisé pour la finition des parois et des faces. Le siège de plaquette robuste encastré dans la fraise garantit une grande précision de la plaquette indexable et un fonctionnement régulier de l'outil.

- Finition des surfaces murales ou frontales
- Nombre élevé de dents pour une plus grande avance
- Disponible en version vissée ou interface de connexion DuoPlug®
- Le rayon d'angle R0.8 de la plaquette réduit la pression de coupe

Désignation	d1	l	r	l3	d2	d3	z	Prix tarif € net HT
VF09-016-E08-02-R+	16	9,52	0,8	27,5	M 8	13,8	2	255,50
VF09-020-E10-03-R+	20	9,52	0,8	27,5	M 10	18,0	3	314,44
VF09-025-E12-04-R+	25	9,52	0,8	32,5	M 12	21,0	4	345,67
VF09-032-E16-05-R+	32	9,52	0,8	32,5	M 16	29,0	5	387,34

Milling cutter:	VF09-025-E12-04
D _c :	25 mm
Cooling:	air outside
Indexable insert:	VF09-8035-R08-LH-2
V _c (speed):	400 m/min
n (revolutions):	6366 min-1
f _t (feed per tooth):	0,25 mm
V _f (feed rate):	4775 mm/min
a _p (depth of cut):	0,5 mm
a _e (width of cut):	0,3 mm

Milling cutter:	VF09-025-E12-04
D _c :	25 mm
Cooling:	air outside
Indexable insert:	VF09-8035-R08-LH-2
V _c (speed):	400 m/min
n (revolutions):	5093 min-1
f _t (feed per tooth):	0,25 mm
V _f (feed rate):	5093 mm/min
a _p (depth of cut):	1 mm
a _e (width of cut):	1,5 mm

Indexable inserts	Catalogue no.	DIN description	Carbide Grade	Coating	l/d	s	r	Torx-screw
	VF09-8035-R08-LH-2	BPHX 090308 PER-1.5	HSC 05	PPTi	9.52	2.38	0.8	M 2.5

18,30 € HT

FOURWORX®

Les fraises à plaquettes indexables Fourworx® sont des fraises à avance rapide qui offrent des performances encore plus élevées pour l'ébauche et l'usinage moyen de différents matériaux.

La géométrie sophistiquée des outils et des plaquettes garantit les hautes performances de ce système d'outillage économique. Elle permet une réduction de 50 % des contraintes dans l'outil. Le système de fraisage offre des performances optimales en usinage à sec et en usinage humide, y compris sur des composants instables et dans des cavités profondes.

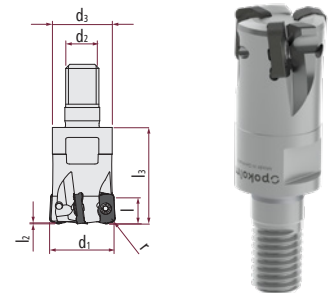
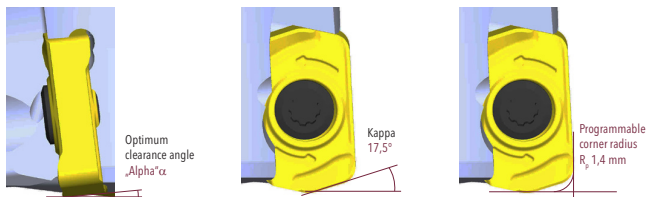

Code	Désignation	d1	l/d	rp	l3	l2	d2	d3	z	Prix tarif € net HT
	FR05-016-E08-02	16	9	1,4*	29	0,35	M 8	13,8	2	242,72
	FR05-016-E08-03	16	9	1,4*	29	0,35	M 8	13,8	3	264,65
	FR05-020-E10-04	20	9	1,4*	29	0,40	M 10	18,0	4	303,70
	FR05-025-E12-05	25	9	1,4*	33	0,45	M 12	21,0	5	352,46
	FR05-032-E16-05	32	9	1,4*	42	0,50	M 16	29,0	5	376,90
	FR05-035-E16-06	35	9	1,4*	42	0,50	M 16	29,0	6	398,82
	FR05-042-E16-06	42	9	1,4*	42	0,55	M 16	29,0	6	415,95
087442	FR05-8062-HF-RK	LNKX 0925 ZSR K10								14,62
087022	FR05-8096-HF-MM	LNKX 0925 ZER M40								14,62
087004	FR05-8242-HF-RP	LNKX 0925 ZSR P40								14,62

FRAISES MULTIFONCTIONS | SLOTWORX



DUOPLUG® Threaded shanks Plain shank Shell type

Milling cutter bodies		Catalogue no.										Accessories		Features	
		d ₁	l	r	l ₁	l ₂	l ₃	d ₂	d ₃	z					

Threaded shank end mill bodies															
	2 16 267	16	10	0.8-2	29	2.5	-	M 8	13.8	2	A, C, D, E, F	✓	✓	✓	✓
	2 16 267 R+	16	10	3/4	29	2.5	-	M 8	13.8	2	A, C, D, E, F	✓	✓	✓	✓
	2 20 267	20	10	0.8-2	29	2.5	-	M 10	18	2	A, C, D, E, F	✓	✓	✓	✓
	2 20 267 R+	20	10	3/4	29	2.5	-	M 10	18	2	A, C, D, E, F	✓	✓	✓	✓
	3 20 267	20	10	0.8-2	29	2.5	-	M 10	18	3	A, C, D, E, F	✓	✓	✓	✓
	3 20 267 R+	20	10	3/4	29	2.5	-	M 10	18	3	A, C, D, E, F	✓	✓	✓	✓
	3 25 267	25	10	0.8-2	33	2.5	-	M 12	21	3	A, C, D, E, F	✓	✓	✓	✓
	3 25 267 R+	25	10	3/4	33	2.5	-	M 12	21	3	A, C, D, E, F	✓	✓	✓	✓
	4 25 267	25	10	0.8-2	33	2.5	-	M 12	21	4	A, C, D, E, F	✓	✓	✓	✓
	4 25 267 R+	25	10	3/4	33	2.5	-	M 12	21	4	A, C, D, E, F	✓	✓	✓	✓
	4 32 267	32	10	0.8-2	43	2.5	-	M 16	29	4	B, C, D, E, F	✓	✓	✓	✓
	4 32 267 R+	32	10	3/4	43	2.5	-	M 16	29	4	B, C, D, E, F	✓	✓	✓	✓
	5 32 267	32	10	0.8-2	43	2.5	-	M 16	29	5	B, C, D, E, F	✓	✓	✓	✓
	5 32 267 R+	32	10	3/4	43	2.5	-	M 16	29	5	B, C, D, E, F	✓	✓	✓	✓
	5 42 267	42	10	0.8-2	43	2.5	-	M 16	29	5	B, C, D, E, F	✓	✓	✓	✓
	5 42 267 R+	42	10	3/4	43	2.5	-	M 16	29	5	B, C, D, E, F	✓	✓	✓	✓

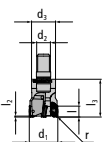

Plain shank end mill bodies															
	2 32 16 167 G	16	10	0.8-2	32	2.5	165	diam. 16	-	2	A, C, D, E, F	✓	✓	✓	✓
	2 32 16 167 G R+	16	10	3/4	32	2.5	165	diam. 16	-	2	A, C, D, E, F	✓	✓	✓	✓
	3 40 20 167 G	20	10	0.8-2	40	2.5	165	diam. 20	-	3	A, C, D, E, F	✓	✓	✓	✓
	3 40 20 167 G R+	20	10	3/4	40	2.5	165	diam. 20	-	3	A, C, D, E, F	✓	✓	✓	✓
	3 50 25 167 G	25	10	0.8-2	50	2.5	225	diam. 25	-	3	A, C, D, E, F	✓	✓	✓	✓
	3 50 25 167 G R+	25	10	3/4	50	2.5	225	diam. 25	-	3	A, C, D, E, F	✓	✓	✓	✓
	4 50 25 167 G	25	10	0.8-2	50	2.5	225	diam. 25	-	4	A, C, D, E, F	✓	✓	✓	✓
	4 50 25 167 G R+	25	10	3/4	50	2.5	225	diam. 25	-	4	A, C, D, E, F	✓	✓	✓	✓

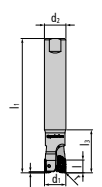

Shell type milling cutter bodies															
	5 42 367	42	10	0.8-2	43	2.5	-	diam. 16	35	5	B, C, D, E, F	✓	✓	✓	✓
	5 42 367 R+	42	10	3/4	43	2.5	-	diam. 16	35	5	B, C, D, E, F	✓	✓	✓	✓
	6 52 367	52	10	0.8-2	53	2.5	-	diam. 22	40	6	B, C, D, E, F	✓	✓	✓	✓
	6 52 367 R+	52	10	3/4	53	2.5	-	diam. 22	40	6	B, C, D, E, F	✓	✓	✓	✓

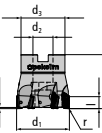

Accessories					

Les fraises Slotworx® de taille M sont multifonctionnelles et disposent de la gamme de plaquettes la plus complète. Par exemple, en passant à une plaquette à grande avance, vous pouvez transformer la fraise à épaulement et à rainurer en une fraise à grande avance en un clin d'œil.

Les plaquettes spécialement développées conviennent à l'usinage dur à grande avance de tous les matériaux jusqu'à une dureté de 60 + 2 HRC. La géométrie de la face de coupe spécialement développée pour ces outils garantit également une durée de vie extrêmement longue et un fonctionnement sans à-coups.

Par ailleurs, les fraises Slotworx® de taille L permettent d'atteindre facilement des profondeurs de coupe allant jusqu'à 14 mm. Ces systèmes de fraisage offrent ainsi des taux d'enlèvement de métal exceptionnels et des vitesses de processus élevées.

Indexable inserts									
	Catalogue no.	DIN Specification	Carbide Grade	Coating	l	s	r	M	
	04 67 837 R08	XDMT 10T308 ER	HSC 05	PVFN	10	3.58	0.8	M 2.5	
	04 67 848 R08	XDMT 10T308 ER	P40	PVGO	10	3.58	0.8	M 2.5	
	04 67 820	XDHT 10T310 ER	K10	polished	10	3.58	1	M 2.5	
	04 67 837	XDMT 10T310 ER	HSC 05	PVFN	10	3.58	1	M 2.5	
	04 67 844	XDHT 10T310 ER	P40	PVGO	10	3.58	1	M 2.5	
	04 67 848	XDMT 10T310 ER	P40	PVGO	10	3.58	1	M 2.5	
	04 67 860	XDHT 10T310 ER	K10	PVTi	10	3.58	1	M 2.5	
	04 67 860 D	XDHT 10T310 ER	K10	PVDiaN	10	3.58	1	M 2.5	
	04 67 894	XDHT 10T310 ER	PCD	uncoated	10	3.58	1	M 2.5	
	04 67 896	XDMT 10T310 ER	M40	PVST	10	3.58	1	M 2.5	
	04 67 820 R20	XDHT 10T320 FR	K10	polished	10	3.58	2	M 2.5	
	04 67 896 R20	XDMT 10T320 ER	M40	PVST	10	3.58	2	M 2.5	
	04 67 820 R30	XDHT 10T330 FR	K10	polished	10	3.58	3	M 2.5	
	04 67 896 R30	XDMT 10T330 ER	M40	PVST	10	3.58	3	M 2.5	
	04 67 820 R40	XDHT 10T340 FR	K10	polished	10	3.58	4	M 2.5	
	04 67 896 R40	XDMT 10T340 ER	M40	PVST	10	3.58	4	M 2.5	

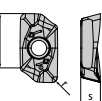

FRAISES À SURFACER | MIRROWORX | PLANWORX

La fraise à surfacer Mirroworx® est conçue avec seulement deux plaquettes indexables et dispose d'un système de réglage fin simple et efficace, grâce à deux vis permettant de corriger le faux-rond axial au micromètre près.

MIRROWORX® S

Ø 16 - 35 mm

Ce système d'outils est disponible en tailles S et M. Alors que la taille S est particulièrement adaptée aux petites surfaces et aux surfaces avec parois (poches, rainures), la taille M excelle dans les espaces ouverts de taille moyenne à très grande.

Désignation	d1	l	r	l3	l2	d2	d3	z	Prix tarif € net HT
1 16 283	16	8,2	0,5	18,0	1	M 8	13,8	1	225,70
2 20 283	20	8,2	0,5	18,0	1	M 10	18,0	2	237,81
2 25 283	25	8,2	0,5	22,5	1	M 12	21,0	2	286,68
2 30 283	30	8,2	0,5	28,0	1	M 12	29,0	2	335,44
2 32 283	32	8,2	0,5	28,0	1	M 16	29,0	2	345,15
2 35 283	35	8,2	0,5	28,0	1	M 16	29,0	2	347,66
03 83 835	TOHX 063005 ER HSC								21,32
03 83 836	TOHX 063005 ER HSC								21,32

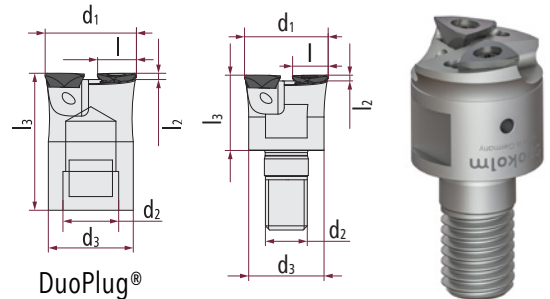

MIRROWORX® M

Ø 42 - 100 mm

Désignation	d1	l	r	l3	l2	d2	d3	z	Prix tarif € net HT
2 42 384	42	14,32		43,0	1	16	35,0	2	383,88
2 52 384	52	14,32		43,0	1	22	48,0	2	462,20
2 66 384	66	14,32		53,0	1	27	60,0	2	539,11
2 80 384	80	14,32		53,0	1	27	60,0	2	618,63
2 100 384	100	14,32		53,0	1	32	70,0	2	695,65
04 84 835	TEHX 16T3 ZF								23,89

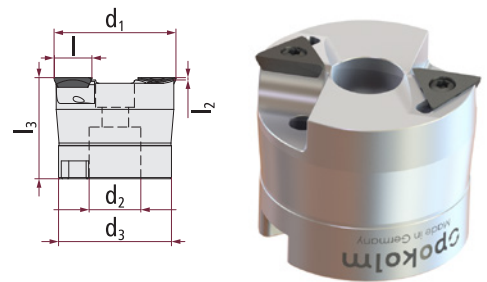

La fraise à plaquettes indexables Planworx® est une solution tout-en-un pour le surfacage. Le corps de fraise Planworx®, revêtu et trempé, se distingue par sa longue durée de vie et la grande stabilité de sa denture, même sous des charges extrêmes.

PLANWORX®

Plaquettes 8 arêtes de coupe

Planworx® est disponible en différentes tailles. Jusqu'à un diamètre de 125 mm, des orifices de refroidissement sont prévus pour l'alimentation interne en liquide de refroidissement de différents fluides. Grâce à son pas différentiel, qui élimine les vibrations de résonance, Planworx® garantit également un fonctionnement d'une grande fluidité.

Désignation	d1	l2	l	l3	d2	d3	r	z	Prix tarif € net HT
4 40 331	40	6,7	13	42	22	40		4	315,70
5 50 331	50	6,7	13	52	27	48		5	374,93
6 63 331	63	6,7	13	52	27	60		6	434,38
8 80 331	80	6,7	13	52	32	70		8	511,29
10 100 331	100	6,7	13	52	40	90		10	570,74
12 125 331	125	6,7	13	52	40	90		12	662,81
14 160 331	160	6,7	13	52	40	120		14	835,82
16 200 331	200	6,7	13	52	60	160		16	1097,20
20 250 331	250	6,7	13	52	60	160		20	1625,61
05 31 842	SNMX 135408 ER P40								18,44
05 31 862	SNMX 135408 ER M40								18,44

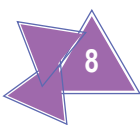
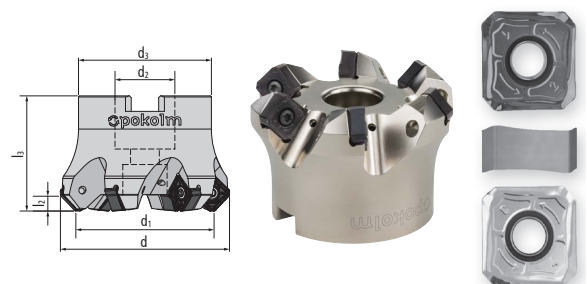

FRAISES CARBURE | FRAISE À USINAGE INOX - TITANE

Articles 288... / 289... / 266...

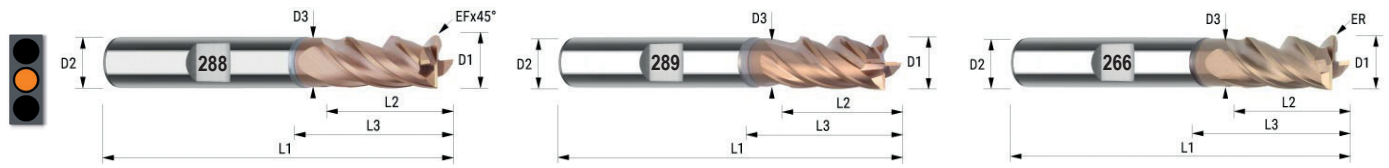

288 / 289 INOX

266 TITANE | INCONEL

D1	D2	L2	L1	D3	L3	EF	Z	Référence	Code HA	Prix promo € net HT	Code HB	Prix promo € net HT	ER	Référence	Code HA	Prix promo € net HT	Code HB	Prix promo € net HT
3,00	6,00	8	57	-	-	0,06	4	288.031...	364341	37,39	363763	38,25	0,10	266.031...	364442	49,64	364451	51,03
4,00	6,00	11	57	-	-	0,08	4	288.041...	364342	37,39	363764	38,25	0,10	266.041...	364443	49,64	364452	51,03
5,00	6,00	13	57	-	-	0,10	4	288.051...	364343	37,39	363765	38,25	0,10	266.051...	364444	49,64	364453	51,03
6,00	6,00	13	57	5,50	21	-	4	289.060...	364349	41,33	363757	42,28	0,10	266.060...	364445	49,64	364454	51,03
8,00	8,00	19	63	7,50	27	-	4	289.080...	364350	56,03	363758	56,98	0,20	266.080...	364446	63,65	364455	65,08
10,00	10,00	22	72	9,50	32	-	4	289.100...	364351	80,62	363759	82,11	0,20	266.100...	364447	85,31	364456	87,25
12,00	12,00	26	83	11,50	38	-	4	289.120...	364352	106,93	363760	108,43	0,20	266.120...	364448	118,40	364457	120,37
16,00	16,00	32	92	15,50	44	-	4	289.160...	364353	190,74	363761	192,83	0,30	266.160...	364449	180,65	364458	183,35
20,00	20,00	38	104	19,50	54	-	4	289.200...	364354	259,97	363762	262,49	0,30	266.200...	364450	263,29	364459	266,52

FRAISES CARBURE | HELICE VARIABLE 4Z INOX

InovaTools
GERMAN TOOLS GROUP

INCONEL | TITANE | INOX

Articles 1.393 ...

SÉRIE NORMALE -
DÉGAGEMENT ARRIÈRE - RAYONNÉE

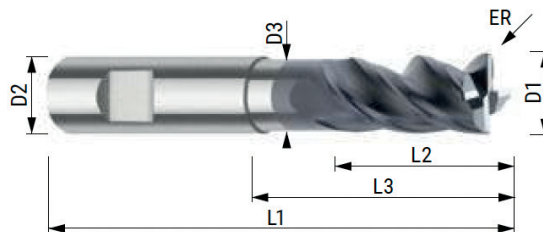

D1	D2	L2	L1	D3	L3	ER	Z	Articles	Code	Prix promo € net HT	D1	D2	L2	L1	D3	L3	ER	Z	Articles	Code	Prix promo € net HT	
8,00	8,00	19	63	7,5	27	0,5	4	1.393.081.10	366905	36,94	12,00	12,00	26	83	11,5	38	2,5	4	1.393.125.10	366923	70,98	
8,00	8,00	19	63	7,5	27	1,0	4	1.393.082.10	366906	36,94	12,00	12,00	26	83	11,5	38	3,0	4	1.393.126.10	366924	70,98	
8,00	8,00	19	63	7,5	27	1,5	4	1.393.083.10	366907	36,94	12,00	12,00	26	83	11,5	38	4,0	4	1.393.127.10	366925	70,98	
8,00	8,00	19	63	7,5	27	2,0	4	1.393.084.10	366908	36,94	16,00	16,00	32	92	15,5	44	0,5	4	1.393.161.10	366927	108,98	
8,00	8,00	19	63	7,5	27	2,5	4	1.393.085.10	366909	36,94	16,00	16,00	32	92	15,5	44	1,0	4	1.393.162.10	366928	108,98	
10,00	10,00	22	72	9,5	32	0,5	4	1.393.101.10	366911	51,97	16,00	16,00	32	92	15,5	44	1,5	4	1.393.163.10	366929	108,98	
10,00	10,00	22	72	9,5	32	1,0	4	1.393.102.10	366912	51,97	16,00	16,00	32	92	15,5	44	2,0	4	1.393.164.10	366930	108,98	
10,00	10,00	22	72	9,5	32	1,5	4	1.393.103.10	366913	51,97	16,00	16,00	32	92	15,5	44	2,5	4	1.393.164.10	366931	108,98	
10,00	10,00	22	72	9,5	32	2,0	4	1.393.104.10	366914	51,97	16,00	16,00	32	92	15,5	44	3,0	4	1.393.166.10	366932	108,98	
10,00	10,00	22	72	9,5	32	2,5	4	1.393.105.10	366915	51,97	16,00	16,00	32	92	15,5	44	4,0	4	1.393.167.10	366933	108,98	
10,00	10,00	22	72	9,5	32	3,0	4	1.393.106.10	366916	51,97	20,00	20,00	38	104	19,5	54	0,5	4	1.393.201.10	366935	159,87	
10,00	10,00	22	72	9,5	32	4,0	4	1.393.107.10	366917	51,97	20,00	20,00	38	104	19,5	54	1,0	4	1.393.202.10	366936	159,87	
12,00	12,00	26	83	11,5	38	0,5	4	1.393.121.10	366919	70,98	20,00	20,00	38	104	19,5	54	1,5	4	1.393.203.10	366937	159,87	
12,00	12,00	26	83	11,5	38	1,0	4	1.393.122.10	366920	70,98	20,00	20,00	38	104	19,5	54	2,0	4	1.393.204.10	366938	159,87	
12,00	12,00	26	83	11,5	38	1,5	4	1.393.123.10	366921	70,98												
12,00	12,00	26	83	11,5	38	2,0	4	1.393.124.10	366922	70,98												

FRAISES CARBURE | HELICE VARIABLE 4Z INOX



INCONEL | TITANE | INOX



Articles 1.389 ...

SÉRIE NORMALE

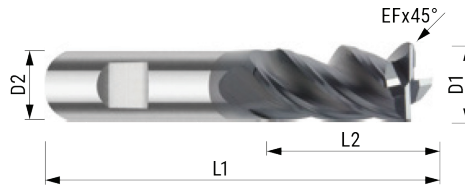

D1	D2 H6	L2	L1	EF	Z	Articles	Code	Prix promo € net HT
6,00	6,00	13	57	0,20	4	1.389.060.10	366082	15,29
8,00	8,00	19	63	0,20	4	1.389.080.10	366083	19,94
10,00	10,00	22	72	0,20	4	1.389.100.10	366084	29,29
12,00	12,00	26	83	0,30	4	1.389.120.10	366085	40,06
16,00	16,00	32	92	0,30	4	1.389.160.10	366086	63,05
20,00	20,00	38	104	0,40	4	1.389.200.10	366087	97,64

| DANS LA LIMITE DES STOCKS DISPONIBLES |

Articles 1.390 ...

SÉRIE NORMALE - DÉGAGEMENT ARRIÈRE

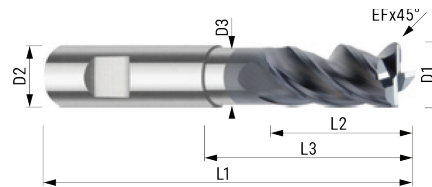

D1	D2	L2	L1	D3	L3	EF	Z	Articles	HA	HB	Code		Prix promo € net HT
											HA	HB	
3,00	6,00	8	57	2,75	18	0,10	4	1.390.03000	.10	366330	366901	24,34
4,00	6,00	11	57	3,50	21	0,13	4	1.390.04000	.10	366331	366902	24,34
5,00	6,00	13	57	4,50	21	0,20	4	1.390.05000	.10	366332	366903	24,34
6,00	6,00	13	57	5,50	21	0,20	4	1.390.06000	.10	366333	366090	24,34
8,00	8,00	19	63	7,50	27	0,20	4	1.390.08000	.10	366334	366091	33,58
10,00	10,00	22	72	9,50	32	0,20	4	1.390.10000	.10	366335	366092	47,39
12,00	12,00	26	83	11,50	38	0,30	4	1.390.12000	.10	366336	366093	65,63
16,00	16,00	32	92	15,50	44	0,30	4	1.390.16000	.10	366337	366094	101,47
20,00	20,00	38	104	19,50	54	0,40	4	1.390.20000	.10	366338	366095	150,40

Articles 1.388...

SÉRIE EXTRA COURTE

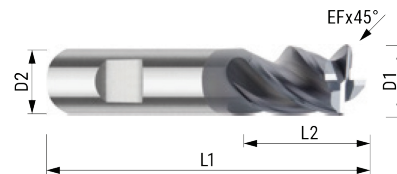

D1	D2 H6	L2	L1	EF	Z	Articles	Code	Prix promo € net HT
3,00	6,00	6	54	0,10	4	1.388.030.10	366058	20,74
4,00	6,00	8	54	0,13	4	1.388.040.10	366059	20,74
5,00	6,00	9	54	0,18	4	1.388.050.10	366060	20,74
6,00	6,00	10	54	0,20	4	1.388.060.10	366052	20,74
8,00	8,00	12	58	0,20	4	1.388.080.10	366053	25,93
10,00	10,00	14	66	0,20	4	1.388.100.10	366054	37,41
12,00	12,00	16	73	0,30	4	1.388.120.10	366055	37,31
16,00	16,00	22	82	0,30	4	1.388.160.10	366056	91,88
20,00	20,00	26	92	0,40	4	1.388.200.10	366057	137,70

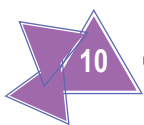

FRAISES CARBURE | HELICE VARIABLE 4Z INOX

InovaTools
GERMAN TOOLS GROUP

TITANE | INOX

Articles 1.392 ...

SÉRIE NORMALE - BEC VIF

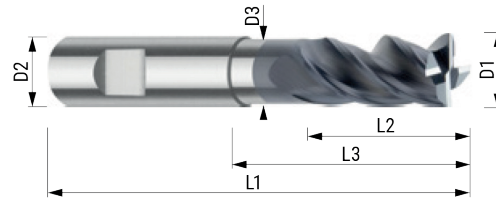

D1	D2 H6	L2	L1	D3	L3	Z	Articles	Code	Prix promo € net HT
3,00	6,00	8	57	2,75	18	4	1.392.030.10	366021	25,45
4,00	6,00	11	57	3,50	21	4	1.392.040.10	366022	25,45
5,00	6,00	13	57	4,50	21	4	1.392.050.10	366023	25,45
6,00	6,00	13	57	5,50	21	4	1.392.060.10	366024	25,45
8,00	8,00	19	63	7,50	27	4	1.392.080.10	366025	34,72
10,00	10,00	22	78	9,50	32	4	1.392.100.10	366026	49,15
12,00	12,00	26	83	11,50	38	4	1.392.120.10	366027	67,40
16,00	16,00	32	92	15,50	44	4	1.392.160.10	366028	103,96
20,00	20,00	38	104	19,50	54	4	1.392.200.10	366029	153,40

FRAISES CARBURE | HELICE VARIABLE 3Z INOX

InovaTools
GERMAN TOOLS GROUP

INOX

Articles 1.391 ...

SÉRIE NORMALE

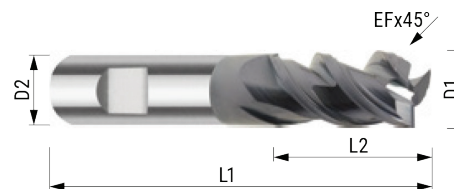

D1	D2 H6	L2	L1	EF	Z	Articles	Code	Prix promo € net HT
3,00	6,00	8	57	0,05	3	1.391.030.10	366134	26,89
4,00	6,00	11	57	0,05	3	1.391.040.10	366135	26,89
5,00	6,00	13	57	0,08	3	1.391.050.10	366136	24,14
6,00	6,00	13	57	0,08	3	1.391.060.10	366137	26,89
7,00	8,00	16	63	0,08	3	1.391.070.10	366138	37,09
8,00	8,00	19	63	0,10	3	1.391.080.10	366139	36,07
9,00	10,00	19	72	0,10	3	1.391.090.10	366140	36,60
10,00	10,00	22	72	0,10	3	1.391.100.10	366141	50,37
12,00	12,00	26	83	0,15	3	1.391.120.10	366142	77,45
16,00	16,00	32	92	0,20	3	1.391.160.10	366143	111,91
20,00	20,00	38	104	0,20	3	1.391.200.10	366144	179,34

FRAISES CARBURE | FRAISES A CHANFREINER 60° / 90°

InovaTools
GERMAN TOOLS GROUP

TITANE | INOX | ACIER | FONTE

Articles 1.795 ... / 760

SÉRIE NORMALE

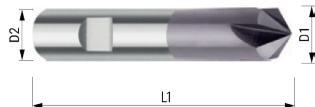

D1	D2	H6	L1	Articles	Z	Code	Prix promo € net HT	Articles	Z	Code	Prix promo € net HT
4,00	4,00	54		1.795.040.10	4	366176	18,81	760.040.00	4	363777	23,84
6,00	6,00	57		1.795.060.10	4	366177	24,23	760.060.00	4	363778	29,52
8,00	8,00	63		1.795.080.10	4	366178	31,98	760.080.00	5	363779	39,33
10,00	10,00	72		1.795.100.10	4	366179	38,11	760.100.00	6	363780	46,33
12,00	12,00	83		1.795.120.10	4	366180	56,42	760.120.00	6	363781	69,51
16,00	16,00	92		1.795.160.10	4	366181	96,48	760.160.00	6	363782	119,67
20,00	20,00	104		1.795.200.10	6	366182	145,45	760.200.00	6	363783	181,34

FRAISES CARBURE | FRAISES POUR USINAGE DYNAMIQUE 5Z

InovaTools
GERMAN TOOLS GROUP

ACIER

Articles 591 ...

DEUX TAILLES CARBURE MONOBLOC ACIER
POUR FRAISAGE TROCHOÏDAL

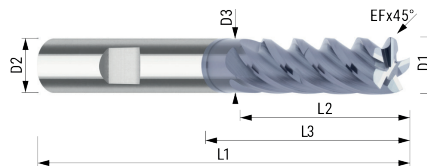

D1	D2	L2	L1	D3	L3	EF	Z	Articles	HA	HB	Code		Prix promo HA € net HT	Prix promo HB € net HT
											HA	HB		
6,00	6,00	18	62	5,80	25	0,10	5	591.06000	.10	364367	364418	37,75	38,49
8,00	8,00	24	68	7,80	30	0,15	5	591.08000	.10	364368	364419	52,63	53,41
10,00	10,00	30	80	9,80	35	0,20	5	591.10000	.10	364369	364420	72,30	73,47
12,00	12,00	36	93	11,80	45	0,20	5	591.12000	.10	364370	364421	95,01	96,19
16,00	16,00	48	108	15,80	55	0,30	5	591.16000	.10	364371	364422	148,39	150,05
20,00	20,00	60	126	19,80	70	0,40	5	591.20000	.10	364372	364423	238,05	240,05

InovaTools
GERMAN TOOLS GROUP

INOX | ACIER

Articles 592 ...

DEUX TAILLES CARBURE MONOBLOC INOX
POUR FRAISAGE TROCHOÏDAL

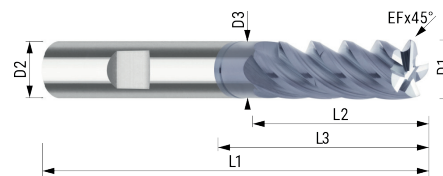

D1	D2	L2	L1	D3	L3	EF	Z	Articles	HA	HB	Code		Prix promo HA € net HT	Prix promo HB € net HT
											HA	HB		
6,00	6,00	18	62	5,80	25	0,10	5	592.06000	.10	364373	364424	45,88	46,63
8,00	8,00	24	68	7,80	30	0,15	5	592.08000	.10	364374	364425	60,33	61,09
10,00	10,00	30	80	9,80	35	0,20	5	592.10000	.10	364375	364426	80,20	81,37
12,00	12,00	36	93	11,80	45	0,20	5	592.12000	.10	364376	364427	101,14	102,32
16,00	16,00	48	108	15,80	55	0,30	5	592.16000	.10	364377	364428	166,95	168,61
20,00	20,00	60	126	19,80	70	0,40	5	592.20000	.10	364378	364429	259,71	261,69



INCONEL | TITANE

Articles 593 ...

FRAISES CARBURE MONOBLOC TITANE
POUR FRAISAGE TROCHOÏDAL

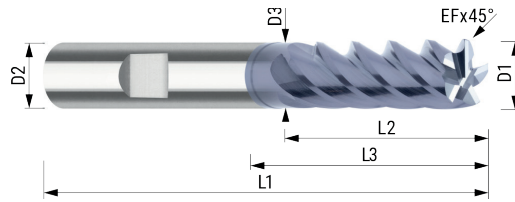

D1	D2 H6	L2	L1	D3	L3	EF	Z	Articles	Code	Prix promo € net HT
6,00	6,00	18	62	5,80	25	0,10	5	593.060.10	363910	53,00
8,00	8,00	24	68	7,80	30	0,15	5	593.080.10	363911	68,77
10,00	10,00	30	80	9,80	35	0,20	5	593.100.10	363912	89,27
12,00	12,00	36	93	11,80	45	0,20	5	593.120.10	363913	114,58
16,00	16,00	48	108	15,80	55	0,30	5	593.160.10	363914	186,53
20,00	20,00	60	126	19,80	70	0,40	5	593.200.10	363915	280,23



INOX | ACIER | FONTE

Articles 595 ...

FRAISE DYNAMIQUE DEUX TAILLES
CARBURE MONOBLOC

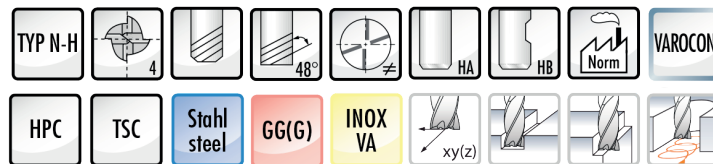
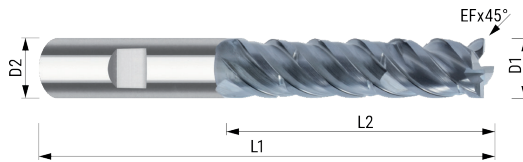

D1	D2 H6	L2	L1	EF	Z	Articles	HA	HB	Code		Prix promo € net HT
									HA	HB	
6,00	6,00	14	54	0,08	4	595.06000	.10	363950	363962	39,19
6,00	6,00	23	80	0,08	4	595.06300	.10	363951	363963	58,42
8,00	8,00	18	60	0,10	4	595.08000	.10	363952	363964	60,58
8,00	8,00	32	100	0,10	4	595.08300	.10	363953	363965	77,50
10,00	10,00	22	70	0,10	4	595.10000	.10	363954	363966	76,56
10,00	10,00	40	100	0,10	4	595.10300	.10	363955	363967	107,78
12,00	12,00	23	83	0,15	4	595.12000	.10	363956	363968	105,91
12,00	12,00	45	110	0,15	4	595.12300	.10	363957	363969	140,86
16,00	16,00	34	92	0,20	4	595.16000	.10	363958	363970	188,10
16,00	16,00	55	150	0,20	4	595.16300	.10	363959	363971	221,89
20,00	20,00	42	104	0,25	4	595.20000	.10	363960	363972	277,14
20,00	20,00	65	150	0,25	4	595.20300	.10	363961	363973	335,32

FRAISES CARBURE | FRAISE HPC INOX 3xD

InovaTools
GERMAN TOOLS GROUP

INOX

Articles 1395 ...

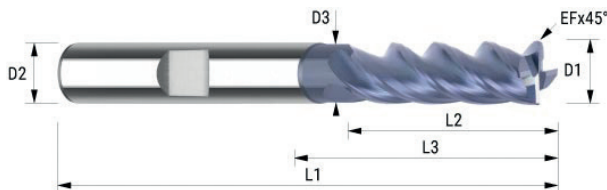

D1	D2	L2	L1	D3	L3	EF	Z	Articles	Code	Prix promo € net HT
6,00	6,00	22	63	5,50	30	0,20	4,00	139506010	3630115	35,16
8,00	8,00	28	80	7,50	36	0,20	4,00	139508010	3630116	42,75
10,00	10,00	33	100	9,50	54	0,20	4,00	139510010	3630117	67,17
12,00	12,00	42	100	11,50	54	0,30	4,00	139512010	3630118	83,00
14,00	14,00	48	100	13,50	54	0,30	4,00	139514010	3630119	120,38
16,00	16,00	53	150	15,50	69	0,30	4,00	139516010	3630120	163,94
18,00	18,00	65	150	17,50	84	0,40	4,00	139518010	3630121	217,17
20,00	20,00	68	150	19,50	84	0,40	4,00	139520010	3630122	252,25

FRAISES CARBURE | FRAISE À COPIER INO-SPEED 4Z

InovaTools
GERMAN TOOLS GROUP

ACIER

Articles 338 ...

FRAISE À COPIER GRANDE AVANCE
CARBURE MONOBLOC TORIQUE INO-SPEED

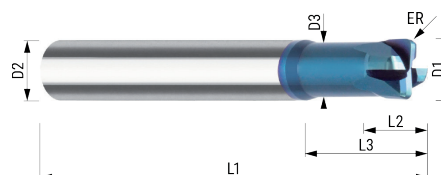

D1	D2	H6	L2	L1	D3	L3	ER	Z	Articles	Code	Prix promo € net HT
2,00	6,00	1,50	50	1,90	6	0,50	4	338.020.05	364379	39,77	
3,00	6,00	2,00	50	2,80	8	0,50	4	338.030.05	364380	39,77	
4,00	6,00	4,50	50	3,80	20	0,50	4	338.040.05	364381	39,77	
5,00	6,00	2,00	60	4,80	10	0,50	4	338.050.05	364382	39,77	
6,00	6,00	2,50	75	5,40	25	0,50	4	338.060.05	364383	39,77	
6,00	6,00	2,50	60	5,40	30	1,00	4	338.060.10	364384	39,77	
8,00	8,00	3,50	75	7,60	40	1,00	4	338.080.10	364385	63,49	
10,00	10,00	4,00	70	9,00	45	1,00	4	339.100.10	364386	81,64	
10,00	10,00	4,00	70	9,00	45	2,00	4	338.100.20	364387	81,52	
12,00	12,00	5,00	80	11,00	45	2,00	4	338.120.20	364389	109,64	
12,00	12,00	5,00	100	11,00	62	1,00	4	338.120.10	364388	118,72	
12,00	12,00	5,00	100	11,00	62	2,00	4	338.121.20	364390	118,72	
16,00	16,00	7,00	120	15,00	70	1,00	4	338.160.10	364391	156,11	
16,00	6,00	7,00	120	15,00	70	2,00	4	338.160.20	364392	156,11	
20,00	20,00	8,00	130	19,00	75	2,00	4	338.200.20	364393	228,18	
20,00	20,00	8,00	130	19,00	75	3,00	4	338.200.30	364394	228,18	

FRAISES CARBURE | FRAISE HPC UNI 3xD

InovaTools
GERMAN TOOLS GROUP

ACIER | FONTE

Articles 1.724...

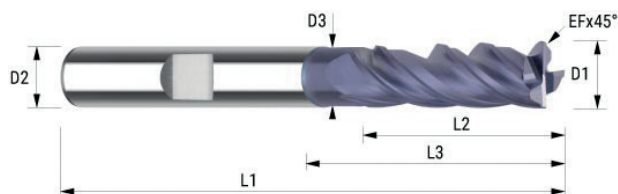

D1	D2	L2	L1	D3	L3	EF	Z	Articles	Code	Prix promo € net HT
6,00	6,00	22	63	5,50	30	0,20	4	172406010	366272	33,76
8,00	8,00	28	80	7,50	36	0,20	4	172408010	366273	42,21
10,00	10,00	33	100	9,50	54	0,20	4	172410010	366274	56,67
12,00	12,00	42	100	11,50	54	0,30	4	172412010	366275	73,38
16,00	16,00	53	150	15,50	69	0,30	4	172416010	366276	133,37
20,00	20,00	68	150	19,50	84	0,40	4	172420010	366277	193,89

FRAISES CARBURE | HELICE VARIABLE 3Z UNIVERSELLE

InovaTools
GERMAN TOOLS GROUP

INOX | ACIER | FONTE

Articles 1.929 ...

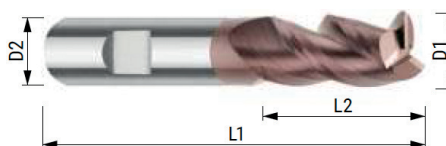

SÉRIE NORMALE



D1	D2	L2	L1	EF	Z	Articles	Code	Prix promo € net HT
3,00	6,00	8	57	0,10	3	1.929.030.10	366185	12,33
4,00	6,00	11	57	0,10	3	1.929.040.10	366186	11,61
5,00	6,00	13	57	0,15	3	1.929.050.10	366187	18,15
6,00	6,00	13	57	0,20	3	1.929.060.10	366188	18,92
8,00	8,00	19	63	0,20	3	1.929.080.10	366189	25,89
10,00	10,00	22	72	0,20	3	1.929.100.10	366190	34,92
12,00	12,00	26	83	0,30	3	1.929.120.10	366191	40,88
16,00	16,00	32	92	0,30	3	1.929.160.10	366192	64,90
20,00	20,00	38	104	0,40	3	1.929.200.10	366193	81,41

Le saviez-vous ?

InovaTools
GERMAN TOOLS GROUP



Usinage haute performance des aciers au chrome et superalliages



Usinage haute performance d'Inox/ aciers alliés (forte résistance à l'oxydation, propre dureté et dureté thermique)



Usinage HSC et dur (forte teneur en aluminium, réfractaire et résistant à l'oxydation)



Revêtement standard universel pour ébauche et finition



Usinage haute performance / usinage dur (couche nano-composite avec haute résistance à la chaleur et à l'oxydation)



Alliages d'Aluminium et Titane (mono-couche pour réduire les arêtes rapportées)



FRAISES CARBURE | HELICE VARIABLE 4Z UNIVERSELLE



INOX | ACIER | FONTE

Articles 1.741...

SÉRIE EXTRA COURTE



D1	D2 H6	L2	L1	EF	Z	Articles	Code	Prix promo € net HT
3,00	6,00	6	54	0,10	4	1.741.030.10	366243	15,95
4,00	6,00	8	54	0,13	4	1.741.040.10	366244	15,95
5,00	6,00	9	54	0,18	4	1.741.050.10	366245	15,95
6,00	6,00	10	54	0,20	4	1.741.060.10	366246	15,95
8,00	8,00	12	58	0,20	4	1.741.080.10	366247	21,31
10,00	10,00	14	66	0,20	4	1.741.100.10	366248	29,31
12,00	12,00	16	73	0,30	4	1.741.120.10	366249	40,26
16,00	16,00	22	82	0,30	4	1.741.160.10	366250	69,10
20,00	20,00	26	92	0,40	4	1.741.200.10	366251	100,97

Articles 1.742 ...

SÉRIE NORMALE

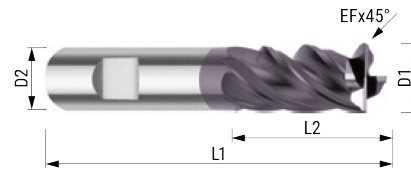

D1	D2 H6	L2	L1	EF	Z	Articles	Code	Prix promo € net HT
6,00	6,00	13	57	0,2	4	1.742.060.10	366255	13,69
8,00	8,00	19	63	0,2	4	1.742.080.10	366256	18,55
10,00	10,00	22	72	0,2	4	1.742.100.10	366257	24,24
12,00	12,00	26	83	0,3	4	1.742.120.10	366258	39,74
16,00	16,00	32	92	0,3	4	1.742.160.10	366259	63,16
20,00	20,00	38	104	0,4	4	1.742.200.10	366260	95,95

| DANS LA LIMITE DES STOCKS DISPONIBLES |

Articles 1.743 ...

SÉRIE NORMALE - DÉGAGEMENT ARRIÈRE

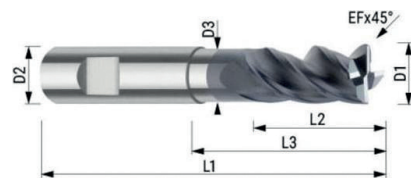

D1	D2	L2	L1	D3	L3	EF	Z	Articles	HA	HB	Code		Prix promo € net HT
											HA	HB	
3,00	6,00	8	57	2,80	18	0,13	4	1.743.03000	.10	366280	366261	20,50
4,00	6,00	11	57	3,60	21	0,13	4	1.743.04000	.10	366281	366262	20,50
5,00	6,00	13	57	4,60	21	0,20	4	1.743.05000	.10	366282	366263	20,50
6,00	6,00	13	57	5,50	21	0,20	4	1.743.06000	.10	366283	366264	20,50
8,00	8,00	19	63	7,50	27	0,20	4	1.743.08000	.10	366284	366265	29,39
10,00	10,00	22	72	9,50	32	0,20	4	1.743.10000	.10	366285	366266	37,56
12,00	12,00	26	83	11,50	38	0,30	4	1.743.12000	.10	366286	366267	52,76
16,00	16,00	32	92	15,50	44	0,30	4	1.743.16000	.10	366287	366268	81,76
20,00	20,00	38	104	19,50	54	0,40	4	1.743.20000	.10	366288	366269	121,47

FRAISES CARBURE | PAS VARIABLE

Fraise ravageuse

ACIER | INOX | FONTE

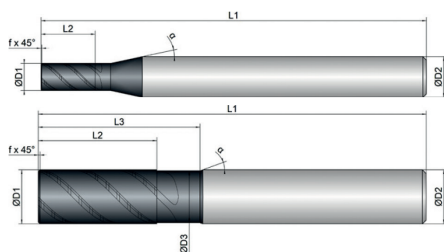

Désignation	D1	D2	L2	L3	L1	Code	HA € net HT	Code	HB € net HT
Fr carb. ravageuse hél. Variable ø 4,0 mm	4.0	6.0	8.0	-	57.0	277001	30,86	277009	31,60
Fr carb. ravageuse hél. Variable ø 5,0 mm	5.0	6.0	9.0	-	57.0	277002	30,86	277010	31,60
Fr carb. ravageuse hél. Variable ø 6,0 mm	6.0	6.0	13.0	19.0	57.0	277003	30,86	277011	30,86
Fr carb. ravageuse hél. Variable ø 8,0 mm	8.0	8.0	19.0	25.0	63.0	277004	40,03	277012	40,03
Fr carb. ravageuse hél. Variable ø 10,0 mm	10.0	10.0	22.0	30.0	72.0	277005	48,49	277013	48,97
Fr carb. ravageuse hél. Variable ø 12,0 mm	12.0	12.0	26.0	36.0	83.0	277006	58,37	277014	65,25
Fr carb. ravageuse hél. Variable ø 16,0 mm	16.0	16.0	31.0	42.0	92.0	277007	104,92	277015	104,92
Fr carb. ravageuse hél. Variable ø 20,0 mm	20.0	20.0	41.0	52.0	104.0	277008	149,00	277016	149,00

FRAISES CARBURE | FRAISE DYNAMIQUE TSC

Articles 600... / 599...

INOX | ACIER | FONTE

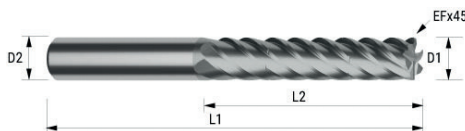

600										599				
D1	D2	EF	F	L2	L1	Articles	Code	Prix promo € net HT		L2	L1	Articles	Code	Prix promo € net HT
10,00	10,00	0,20	6	50	96	60010000	366421	119,97		40	89	59910000	366425	106,78
12,00	12,00	0,24	6	60	112	60012000	366422	157,59		48	100	59912000	366426	129,38
16,00	16,00	0,32	6	80	136	60016000	366423	267,69		64	123	59916000	366427	221,82
20,00	20,00	0,40	6	100	160	60020000	366424	394,63		80	140	59920000	366428	345,06

FRAISES CARBURE | SERIE COURTE 3Z

Articles 351...

INOX | ACIER | FONTE

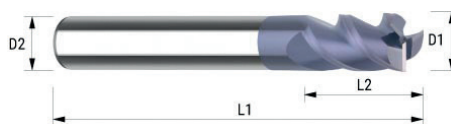

D1h10	D2h6	L2	L1	Z	Référence	Code	Prix promo € net HT
1,00	6	3	50	3	35101000	282286	18,46
1,50	6	4	50	3	35101500	282287	18,46
2,00	6	5	50	3	35102000	282288	18,46
2,50	6	6	50	3	35102500	282289	18,46
3,00	6	7	50	3	35103000	282290	18,46
3,50	6	7	50	3	35103500	282291	18,46
4,00	6	8	50	3	35104000	282292	18,46
4,50	6	9	50	3	35104500	282293	18,46
5,00	6	10	50	3	35105000	282294	18,46
5,50	6	10	50	3	35105500	282295	18,46

FRAISES CARBURE | FRAISE TORIQUE 902

FRAISE 902 TORIQUE

ACIER

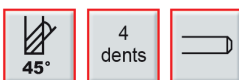

SÉRIE EXTRA LONGUE



D1	D2	HA	L2	L1	Z	R	Code	Prix tarif € net HT
7	6	9	120	4	0,5		363740	110,49
9	8	12	135	4	1		363741	140,12
11	10	15	150	4	1		363742	169,49
13	12	18	160	4	1		363743	219,24
17	16	24	180	4	1,5		363744	365,20

queue réduite

FRAISE 216 - 998

ALUMINIUM

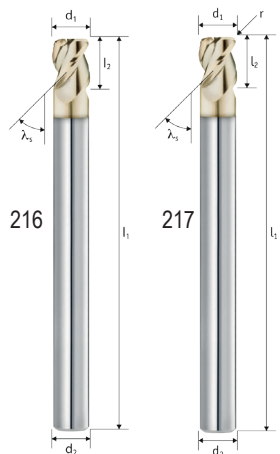

216 45 03C

D1	D2	L2	L1	r	Article	Code	Prix promo € net HT	Article	Code	Prix promo € net HT
7	6	8	125		216 45 03C-070	277072	145,31			
9	8	10	140		216 45 03C-090	277073	194,62			
11	10	13	150		216 45 03C-110	277074	234,46			
13	12	15	150		216 45 03C-130	277075	282,23			
7	6	8	125	1,5				998074244	277076	132,49
9	8	10	140	2				998074246	277077	159,01
11	10	13	150	2				998074248	277078	190,57
13	12	15	150	2,5				998074250	277079	238,21

queue réduite

FRAISES CARBURE | FRAISE D'ÉBAUCHE

InovaTools®
GERMAN TOOLS GROUP

ACIER

Articles 953.1 ...

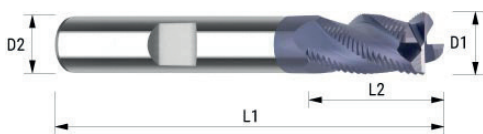

Articles 953.2 ...

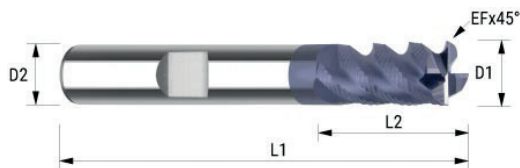

953.1...

D1	D2	L1	L2	Z	HA			HB		
					Articles	Code	Prix promo € net HT	Articles	Code	Prix promo € net HT
3,00	6,00	57	6	3	95310300	366721	14,64			
4,00	6,00	57	8	3	95310400	366722	14,64			
5,00	6,00	57	10	3	95310500	366723	14,64			
6,00	6,00	57	16	3	95310600	366826	16,08	95310610	366606	17,11
8,00	8,00	63	16	3	95310800	366828	21,66	95310810	366608	22,71
10,00	10,00	72	22	4	95311000	366830	31,20	95311010	366610	32,82
12,00	12,00	83	26	4	95311200	366832	46,35	95311210	366612	48,00
16,00	16,00	92	32	4	95311600	366836	75,31	95311610	366616	77,58

953.2...

L2	ER	Z	HA			HB		
			Articles	Code	Prix promo € net HT	Articles	Code	Prix promo € net HT
11	0,15	3	95320400	366844	15,38	95320410	366704	16,39
13	0,15	4	95320500	366845	15,38	95320510	366705	16,39
16	0,15	4	95320600	366846	16,79	95320610	366706	17,82
16	0,15	4	95320800	366848	22,39	95320810	366708	23,43
22	0,2	4	95321000	366850	31,95	95321010	366710	33,56
28	0,2	4	95321200	366852	47,12	95321210	366712	48,72
32	0,25	5	95321600	366856	79,86	95321610	366716	82,12

FRAISES CARBURE | STANDARD - SÉRIES COURTES 2Z 3Z NORMALE 4Z

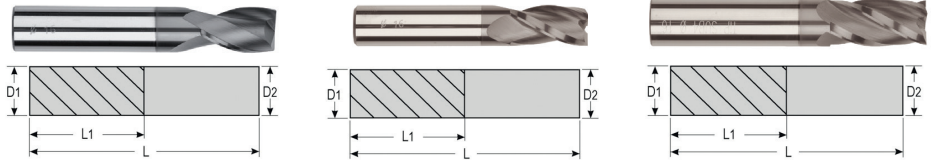

* Jusqu'à épuisement des stocks



		2 dents		3 dents		4 dents							
D1	D2 H6	L1	L	Code	Prix promo € net HT	L1	L	Code	Prix promo € net HT	L1	L	Code	Prix promo € net HT
2	2	6	40	366200	14,75	6	40	366300	15,68	6	40	366400	16,59
2,5	2,5	8	40	366201	15,57	10	40	366301	19,19	10	40	366401	16,12
3	3	8	40	366202	14,76	10	40	366302	15,68	10	40	366402	16,59
3,5	3,5	8	50	366203	15,57	8	50	366303	18,02	10	50	366403	18,02
4	4	12	40	366204	13,49	12	40	366304	15,68	11	50	366404	15,22
4,5	4,5	12	40	366209	15,57	12	40	366307	15,57	12	40	366407	16,12
5	5	14	50	366205	15,28	14	50	366305	18,20	13	50	366405	18,20
5,5	5,5	14	50	366211	19,19	14	50	366309	19,19	14	50	366409	19,74
6	6	16	50	366206	14,61	16	50	366306	18,77	13	57	366406	20,09
6,5	6,5	16	60	366207	19,19	16	60	366311	19,19	16	60	366411	19,74
8	8	20	60	366208	20,63	20	60	366308	25,76	19	63	366408	23,94
10	10	22	70	366210	26,61	22	70	366310	30,76	22	72	366410	32,96
12	12	22	70	366212	37,77	22	70	366312	42,11	26	83	366412	45,81
14	14	-	-	-	-	25	75	366314	71,95	32	92	366414	76,35
16	16	25	75	366216	75,88	25	75	366316	78,12	32	92	366416	90,73
18	18	26	92	366218	90,93	32	100	366318	89,13	38	100	366418	95,56
20	20	32	100	366220	107,28	32	100	366320	118,30	38	100	366420	127,47

FRAISES CARBURE | ALU QUEUE RÉDUITE



d1	d2	l2	l1	r	Z	Référence	Code	€ promo ht
2	1,9	3	40	0,1	2	216 27 02-02040	277150	63,72
3	2,9	4	60	0,1	2	216 27 02-03060	277151	63,72
4	3,8	5	60	0,1	2	216 27 02-04060	277152	63,72
5	4,8	8	70	0,1	2	216 27 02-05070	277153	72,30
6	5,8	8	100	0,1	2	216 27 02-06100	277154	83,17
8	7,8	10	100	0,1	2	216 27 02-08100	277155	98,16
10	9,7	14	100	0,1	2	216 27 02-10100	277156	113,32
12	11,7	16	125	0,1	2	216 27 02-12125	277157	151,09
16	15,7	20	125	0,1	2	216 27 02-16125	277158	215,86

▲
queue réduite



Schaft / Queue Tol. h7	Zähne Dents	Typ / Type Tol. h7	λ_s
	2	W	27°
Schneidstoff Matériau	Zentrumschneiden Coupe au centre		
HM			

P	M	K	N	S	H

FRAISES HÉMISPHERIQUE ALU

Articles 2.411 ...

ALUMINIUM

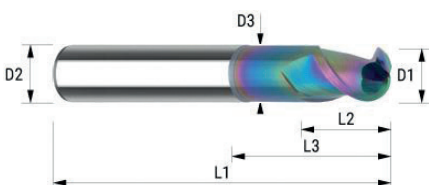

D1	D2	L2	L1	L3	Code	Référence	Prix promo € net HT
3.0	3.0	6	50	16	277020	241103000	45,79
4.0	4.0	7	54	17	277021	241104000	45,79
5.0	5.0	8	54	18	277022	241105000	45,79
6.0	6.0	10	54	21	277023	241106000	45,79
8.0	8.0	12	59	27	277024	241108000	56,03
10.0	10.0	13	67	32	277025	241110000	74,23
12.0	12.0	16	73	38	277026	241112000	94,97
16.0	16.0	20	83	44	277071	241116000	157,86

Articles 941 ...

ALUMINIUM

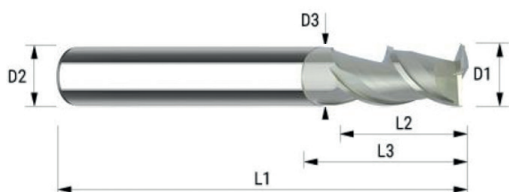
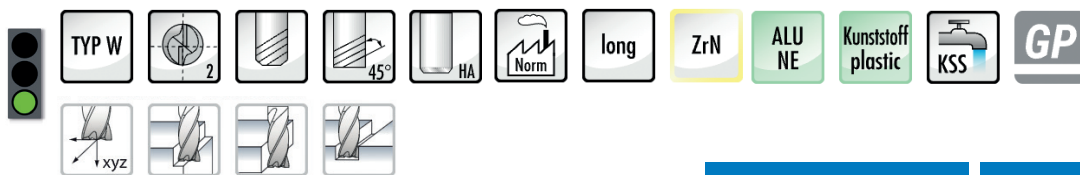

D1	D2	L2	L1	L3	Code	Référence	Prix promo € net HT
3.0	3.0	8	57	16	366063	94110300	17,05
4.0	4.0	11	57	18	366064	94110400	17,05
5.0	5.0	13	57	20	366065	94110500	17,05
6.0	6.0	13	57	20	366066	94110600	18,95
8.0	8.0	19	63	26	366068	94110800	28,95
10.0	10.0	22	72	29	366070	94111000	39,08
12.0	12.0	26	83	36	366072	94112000	54,00
14.0	14.0	26	83	36	366075	94111400	69,18
16.0	16.0	32	92	42	366076	94111600	83,60
18.0	18.0	32	92	42	366078	94118000	108,10
20.0	20.0	38	104	52	366080	94112000	138,05

FRAISES CARBURE | FRAISES HPC

Articles 2.415

ALUMINIUM

FRAISE CARBURE HPC À TROUS D'HUILE

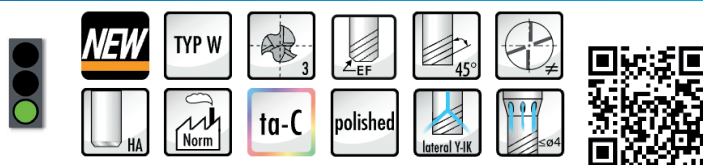
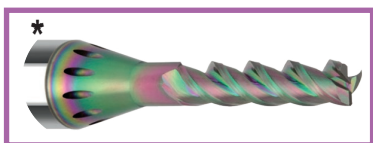
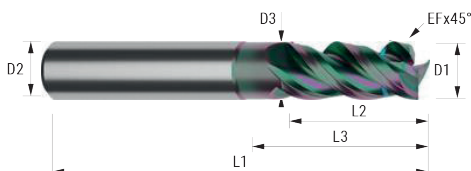

D1	D2	L2	L1	D3	L3	EF	Z	Référence	Code	€ promo ht
3,00	6,00	12	57	2,90	14	0,10	3	241503000	364460	71,51
4,00	6,00	12	57	3,90	15	0,10	3	241504000	364461	71,51
5,00	6,00	15	57	4,90	18	0,10	3	241505000	364462	67,36
6,00	6,00	15	57	5,80	21	0,10	3	241506000	364463	65,24
8,00	8,00	22	64	7,80	28	0,10	3	241508000	364464	76,23
10,00	10,00	25	73	9,70	33	0,20	3	241510000	364465	96,68
12,00	12,00	28	84	11,70	39	0,20	3	241512000	364466	119,20
16,00	16,00	35	93	15,70	45	0,20	3	241516000	364467	177,77
20,00	20,00	41	104	19,50	52	0,20	3	241520000	364468	277,21

Articles 2.416

FRAISE CARBURE HPC TORIQUE

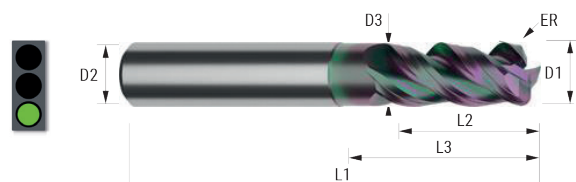
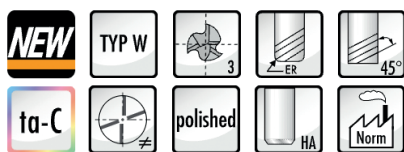

D1	D2	L2	L1	D3	L3	EF	Z	Référence	Code	€ promo ht
5,00	6,00	15	57	4,90	18	0,50	3	241605000	364469	49,13
5,00	6,00	15	57	4,90	18	1,00	3	241605100	364470	49,13
6,00	6,00	15	57	5,80	21	0,50	3	241606000	364471	49,13
6,00	6,00	15	57	5,80	21	1,00	3	241606100	364472	49,13
8,00	8,00	22	64	7,80	28	0,50	3	241608000	364473	55,59
8,00	8,00	22	64	7,80	28	1,00	3	241608100	364474	55,59
10,00	10,00	25	73	9,70	33	0,50	3	241610000	364475	70,99
10,00	10,00	25	73	9,70	33	1,00	3	241610100	364476	70,99
12,00	12,00	28	84	11,70	39	0,50	3	241612000	364477	103,85
12,00	12,00	28	84	11,70	39	1,00	3	241612100	364478	103,85
12,00	12,00	28	84	11,70	39	2,00	3	241612200	364479	103,85
16,00	16,00	35	93	15,70	45	1,00	3	241616000	364480	173,48
16,00	16,00	35	93	15,70	45	2,00	3	241616100	364481	173,48
20,00	20,00	41	104	19,50	52	1,00	3	241620000	364482	273,34
20,00	20,00	41	104	19,50	52	2,00	3	241620100	364483	273,34

FRAISES CARBURE | USINAGE DYNAMIQUE 3Z

InovaTools
GERMAN TOOLS GROUP

ALUMINIUM

Articles 590 ...

DEUX TAILLES CARBURE MONOBLOC ALUMINIUM

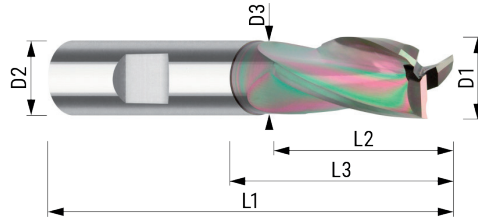

D1	D2 H6	L2	L1	D3	L3	Z	Articles	HA	HB	Code		Prix promo € net HT
										HA	HB	
4,00	4,00	13	54	3,70	16	2	590.04000		363939		49,83
5,00	5,00	15	54	4,70	18	2	590.05000		363940		51,33
6,00	6,00	16	64	5,70	21	2	590.06000	.10	363941	363917	54,66
8,00	8,00	22	70	7,50	27	2	590.08000	.10	363942	363918	72,86
10,00	10,00	25	72	9,50	32	2	590.10000	.10	363943	363919	99,90
12,00	12,00	28	83	11,50	38	3	590.12000	.10	363944	363921	121,06
14,00	14,00	30	83	13,50	42	3	590.14000	.10	363945	363936	159,99
16,00	16,00	36	92	15,50	44	3	590.16000	.10	363946	363922	202,48
18,00	18,00	36	92	17,50	50	3	590.18000	.10	363947	363937	240,24
20,00	20,00	41	104	19,50	54	4	590.20000	.10	363948	363920	311,25
25,00	25,00	43	110	24,50	63	4	590.25000	.10	363949	363938	459,13

FRAISES CARBURE | FRAISE D'ÉBAUCHE 3Z

InovaTools
GERMAN TOOLS GROUP

ALUMINIUM

Articles 251 ...

FRAISE D'ÉBAUCHE CARBURE
MONOBLOC AVEC TROUS D'HUILE PRIMUS

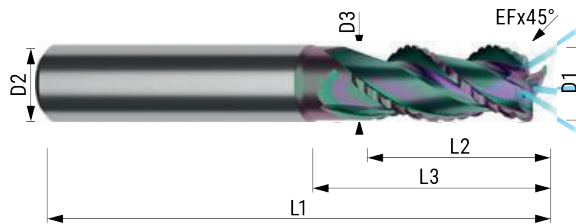

D1	D2 H6	L2	L1	D3	L3	ER	Z	Articles	Code	Prix promo € net HT
6,00	6,00	14	57	5,70	20	0,20	3	251.060.00	3630020	84,37
8,00	8,00	21	63	7,40	26	0,25	3	251.080.00	3630021	99,32
10,00	10,00	23	72	9,50	31	0,30	3	251.100.00	3630022	124,74
12,00	12,00	27	83	11,00	37	0,35	2	251.120.00	3630023	154,65
16,00	16,00	36	92	15,00	43	0,40	3	251.160.00	3630024	214,10
20,00	20,00	41	104	19,00	52	0,40	3	251.200.00	3630025	301,14

FRAISES CARBURE | FRAISE D'ÉBAUCHE 3Z

InovaTools
GERMAN TOOLS GROUP

ALUMINIUM

Articles 2.413

FRAISE D'ÉBAUCHE CARBURE
MONOBLOC PRIMUS

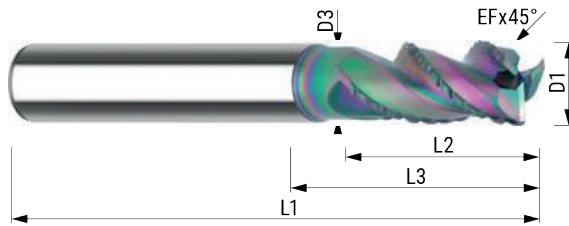

D1	D2 H6	L2	L1	D3	L3	EF	Z	Articles	Code	Prix promo € net HT
6,00	6,00	14	57	5,90	20	0,20	3	2413.060.00	3630073	65,00
8,00	8,00	21	63	7,80	26	0,25	3	2413.080.00	3630074	76,50
10,00	10,00	23	72	8,00	31	0,30	3	2413.100.00	3630075	96,11
12,00	12,00	27	83	11,70	37	0,35	3	2413.120.00	3630076	119,16
16,00	16,00	36	92	15,70	43	0,40	3	2413.160.00	3630077	164,95
20,00	20,00	41	104	19,50	52	0,40	3	2413.200.00	3630078	232,01

FRAISES CARBURE | FRAISE TORIQUE ALUMINIUM 2Z

InovaTools
GERMAN TOOLS GROUP

ALUMINIUM

Articles 2.408... / 2.409...

FRAISE TORIQUES CARBURE
MONOBLOC AVEC RAYON

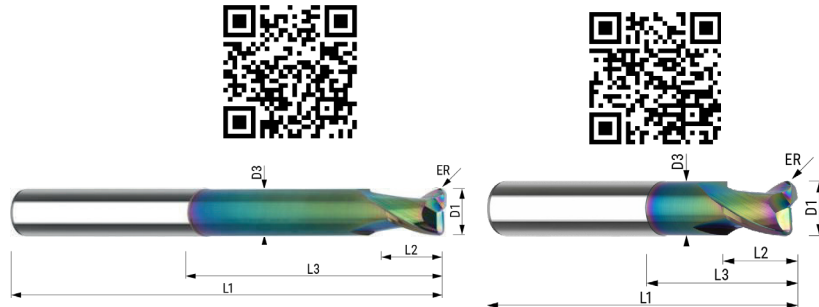

D1	D2 H6	L2	L1	D3	ER	Z	2.408				2.409			
							L3	Articles	Code	Prix promo € net HT	L3	Articles	Code	Prix promo € net HT
3,00	6,00	4	75	2,90	0,30	2	32	2408.030.00	3630026	53,21	14	2409.030.00	3630042	40,10
4,00	6,00	5	75	3,90	0,30	2	36	2408.040.00	3630027	58,94	16	2409.040.00	3630043	46,01
5,00	6,00	6	75	4,90	0,30	2	40	2408.050.00	3630028	65,04	18	2409.050.00	3630044	49,68
6,00	6,00	7	80	5,80	0,30	2	44	2408.060.00	3630029	70,18	21	2409.060.00	3630045	54,99
6,00	6,00	7	80	5,80	1,00	2	44	2408.061.00	3630030	70,18	21	2409.061.00	3630046	54,99
6,00	6,00	7	80	5,80	2,00	2	44	2408.062.00	3630031	70,18	21	2409.062.00	3630047	54,99
8,00	8,00	9	100	7,80	0,30	2	54	2408.080.00	3630032	100,18	27	2409.080.00	3630048	75,07
8,00	8,00	9	100	7,80	1,00	2	54	2408.081.00	3630033	100,18	27	2409.081.00	3630049	75,07
8,00	8,00	9	100	7,80	2,00	2	54	2408.082.00	3630034	100,18	27	2409.082.00	3630050	75,07
10,00	10,00	11	100	9,70	0,30	2	60	2408.100.00	3630035	138,70	32	2409.100.00	3630051	102,11
10,00	10,00	11	100	9,70	1,50	2	60	2408.101.00	3630036	138,70	32	2409.101.00	3630052	102,11
10,00	10,00	11	100	9,70	3,00	2	60	2408.102.00	3630037	138,70	32	2409.102.00	3630053	102,11
12,00	12,00	13	120	11,70	1,50	2	75	2408.120.00	3630038	186,74	38	2409.120.00	3630054	138,36
12,00	12,00	13	120	11,70	4,00	2	75	2408.121.00	3630039	186,74	38	2409.121.00	3630055	138,36
16,00	16,00	17	150	15,70	2,00	2	92	2408.160.00	3630040	317,96	44	2409.160.00	3630056	227,70
16,00	16,00	17	150	15,70	5,00	2	92	2408.161.00	3630041	317,96	44	2409.161.00	3630057	227,70

FRAISES CARBURE | FRAISE TORIQUE ALUMINIUM 2Z | 3Z

Articles 2.414

USINAGE DYNAMIQUE

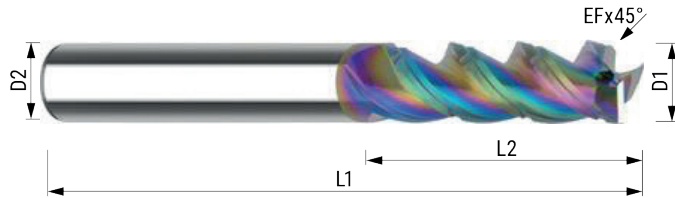

D1	D2 H6	L2	L1	EF	Z	Articles	Code	Prix promo € net HT
6,00	6,00	21	62	0,20	3	2414.060.00	3630079	64,45
8,00	8,00	28	68	0,20	3	2414.080.00	3630080	71,48
10,00	10,00	35	80	0,20	3	2414.100.00	3630081	97,74
12,00	12,00	42	93	0,20	3	2414.120.00	3630082	147,70
16,00	16,00	56	108	0,20	3	2414.160.00	3630083	211,98
20,00	20,00	70	126	0,20	3	2414.200.00	3630084	299,05

FRAISES CARBURE | FRAISE TORIQUE ALUMINIUM 3Z

InovaTools
GERMAN TOOLS GROUP

ALUMINIUM

Articles 2.410

FRAISE CARBURE MONOBLOC
AVEC RAYON

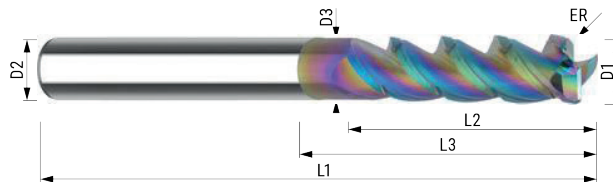

D1	D2 H6	L2	L1	D3	L3	ER	Z	Articles	Code	Prix promo € net HT
6,00	6,00	25	71	5,80	31	0,50	3	2410.060.00	3630058	53,60
6,00	6,00	25	71	5,80	31	1,00	3	2410.061.00	3630059	53,60
8,00	8,00	33	80	7,80	41	0,50	3	2410.080.00	3630060	64,84
8,00	8,00	33	80	7,80	41	1,00	3	2410.081.00	3630061	64,84
8,00	8,00	33	80	7,90	41	2,00	3	2410.082.00	3630062	64,84
10,00	10,00	41	95	9,70	51	0,50	3	2410.100.00	3630063	99,19
10,00	10,00	41	95	9,70	51	1,00	3	2410.101.00	3630064	99,19
10,00	10,00	41	95	9,70	51	2,00	3	2410.102.00	3630065	99,19
12,00	12,00	49	109	11,70	61	0,50	3	2410.120.00	3630066	136,27
12,00	12,00	49	109	11,70	61	1,00	3	2410.121.00	3630067	136,27
12,00	12,00	49	109	11,70	61	2,00	3	2410.122.00	3630068	136,27
16,00	16,00	65	132	15,80	81	2,00	3	2410.160.00	3630069	253,94
16,00	16,00	65	132	15,70	81	3,00	3	2410.161.00	3630070	253,94
20,00	20,00	82	154	19,50	101	2,00	3	2410.200.00	3630071	370,39
20,00	20,00	82	154	19,50	101	3,00	3	2410.201.00	3630072	370,39

FRAISES CARBURE | FRAISE ALUMINIUM 3Z



ALUMINIUM

Articles 945 ...

FRAISE AVEC ARRÊTE VIVE

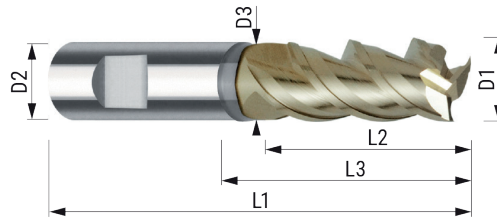

D1	D2	L2	L1	D3	L3	Z	Articles	Code	Prix promo € net HT
3,00	6,00	12	38	-	-	3	945.030.19	366982	23,17
4,00	6,00	12	54	3,80	18	3	945.040.19	366983	23,17
5,00	6,00	15	54	4,80	18	3	945.050.19	366984	23,17
6,00	6,00	16	57	5,80	21	3	945.060.19	366985	25,14
8,00	8,00	22	63	7,80	28	3	945.080.19	366986	37,49
10,00	10,00	25	72	9,70	33	3	945.100.19	366987	50,91
12,00	12,00	28	83	11,70	39	3	945.120.19	366988	68,53
16,00	16,00	35	93	15,70	45	3	945.160.19	366989	104,47
20,00	20,00	40	104	19,70	54	3	945.200.19	366990	162,56
25,00	25,00	40	121	23,00	65	3	945.250.19	366991	287,06

FRAISES CARBURE | FRAISE ALUMINIUM 3Z



ALUMINIUM

Articles 244 ...

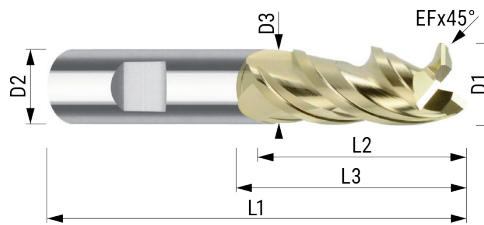

D1	D2	L2	L1	D3	L3	EF	Z	Articles	Code		Prix promo € net HT	
									HA	HB		
3,00	6,00	8	57	2,80	12	0,10	3	244.03000	.10	363810	41,99
4,00	6,00	11	57	3,80	18	0,10	3	244.04000	.10	363811	41,99
5,00	6,00	13	57	4,80	18	0,10	3	244.05000	.10	363812	41,99
6,00	6,00	13	57	5,80	18	0,20	3	244.06000	.10	363813	44,15
6,00	6,00	13	80	5,80	42	0,20	3	244.06100	.10	363814	59,21
8,00	8,00	21	63	7,80	25	0,20	3	244.08000	.10	363815	51,54
8,00	8,00	21	100	7,80	62	0,20	3	244.08100	.10	363816	80,03
10,00	10,00	22	72	9,70	30	0,20	3	244.10000	.10	363817	90,12
10,00	10,00	22	100	9,70	58	0,20	3	244.10100	.10	363818	118,27
12,00	12,00	26	83	11,70	36	0,20	3	244.12000	.10	363819	122,73
12,00	12,00	26	120	11,70	73	0,20	3	244.12100	.10	363820	170,46
16,00	16,00	36	92	15,70	42	0,20	3	244.16000	.10	363821	230,11
16,00	16,00	36	150	15,70	100	0,20	3	244.16100	.10	363822	367,70
18,00	18,00	36	92	17,60	42	0,20	3	244.18000	.10	363823	254,18
18,00	18,00	36	150	17,60	100	0,20	3	244.18100	.10	363824	390,61
20,00	20,00	41	104	19,50	52	0,20	3	244.20000	.10	363825	329,11
20,00	20,00	41	150	19,50	98	0,20	3	244.20100	.10	363826	358,93
25,00	25,00	50	121	24,50	65	3,00	3	244.25000	.10	363827	381,74

FRAISES CARBURE | FRAISE ALUMINIUM CARBURE 3Z NON REVETUE



ALUMINIUM

APFE2000/3000



2 3 H-A 50° h6 shank Grade H05S

DC	Tolerance
Ø1 - Ø5	0.000 ~ -0.020
Ø6 - Ø8	0.000 ~ -0.025
Ø10 - Ø20	0.000 ~ -0.030

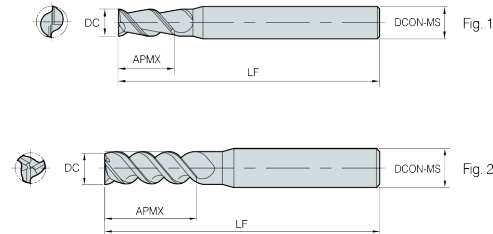

DC	DCON-MS	APMX	LF	Fig.	Référence	Code	€ promo ht
6	6	18	50	1	6-01-027843	368642	26,22
8	8	20	60	1	6-01-027844	368643	36,13
10	10	30	75	1	6-01-027845	368644	52,50
12	12	32	75	1	6-01-027846	368645	67,64
16	16	45	100	1	6-01-027847	368647	164,58
20	20	45	100	1	6-01-027848	368649	256,42
6	6	18	50	2	6-01-027833	280160	27,00
8	8	20	60	2	6-01-027834	280161	37,21
10	10	30	75	2	6-01-027835	280162	54,08
12	12	32	75	2	6-01-027836	280163	69,66
16	16	45	100	2	6-01-027837	280164	169,53
20	20	45	100	2	6-01-027838	280165	264,15

APMFE3000

3 H-A 50° h6 shank Grade H05S

DC	Tolerance
Ø1 - Ø5	0.000 ~ -0.020
Ø6 - Ø8	0.000 ~ -0.025
Ø10 - Ø20	0.000 ~ -0.030

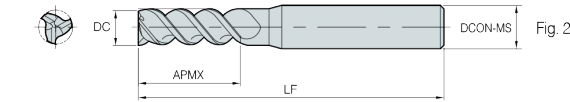

DC	DCON-MS	APMX	LF	Référence	€ tarif ht
3	6	11	60	6-01-042447	28,58
4	6	14	60	6-01-042448	28,58
5	6	17	60	6-01-042449	37,53
6	6	22	65	6-01-042450	40,70
8	8	25	65	6-01-042451	48,83
10	10	37	80	6-01-042452	72,13
12	12	40	80	6-01-042453	92,25
16	16	55	110	6-01-042454	176,41
20	20	60	125	6-01-042455	293,22

h6 queue H-A 45° DLC Revêtement

Tolérance ØD	e8
R Tolérance	±0.005 mm

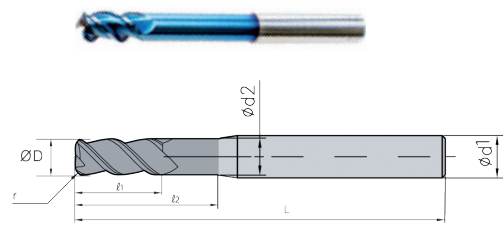
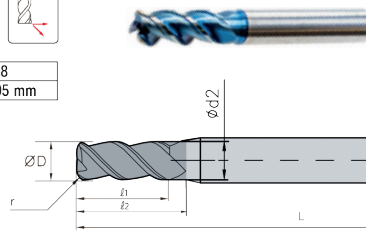

ØD	Ød1	Ød2	R	Queue	APRE3000			Référence	€ tarif ht
					L	I1	I2		
5	6	4,7	0,5	HA	57	13	18	APRE3050-057-R05 KED1000	61,62
5	6	4,7	1,0	HA	57	13	18	APRE3050-057-R10 KED1000	61,62
6	6	5,7	0,5	HA	57	13	18	APRE3060-057-R05 KED1000	61,62
6	6	5,7	1,0	HA	57	13	18	APRE3060-057-R10 KED1000	61,62
8	8	7,4	0,5	HA	63	21	25	APRE3080-063-R05 KED1000	67,28
8	8	7,4	1,0	HA	63	21	25	APRE3080-063-R10 KED1000	67,28
10	10	9,2	0,5	HA	72	22	30	APRE3100-072-R05 KED1000	104,13
10	10	9,2	1,0	HA	72	22	30	APRE3100-072-R10 KED1000	104,13
10	10	9,2	2,0	HA	72	22	30	APRE3100-072-R20 KED1000	104,13
12	12	11,0	0,5	HA	83	26	36	APRE3120-083-R05 KED1000	150,24
12	12	11,0	1,0	HA	83	26	36	APRE3120-083-R10 KED1000	150,24
12	12	11,0	2,0	HA	83	26	36	APRE3120-083-R20 KED1000	150,24
16	16	15,0	1,0	HA	92	36	42	APRE3160-092-R10 KED1000	252,55
16	16	15,0	2,0	HA	92	36	42	APRE3160-092-R20 KED1000	252,55
16	16	15,0	3,0	HA	92	36	42	APRE3160-092-R30 KED1000	252,55

L	I1	I2	APLRE3000		Référence	€ tarif ht	
			L	I1			
83	8	30	83	8	30	APLRE3050-083-R05 KED1000	79,33
83	8	30	83	8	30	APLRE3050-083-R10 KED1000	79,33
83	10	42	83	10	42	APLRE3060-083-R05 KED1000	79,33
83	10	42	83	10	42	APLRE3060-083-R10 KED1000	79,33
100	13	62	100	13	62	APLRE3080-100-R05 KED1000	103,59
100	13	62	100	13	62	APLRE3080-100-R10 KED1000	103,59
100	16	58	100	16	58	APLRE3100-100-R05 KED1000	143,31
100	16	58	100	16	58	APLRE3100-100-R10 KED1000	143,31
100	16	58	100	16	58	APLRE3100-100-R20 KED1000	143,31
119	19	73	119	19	73	APLRE3120-119-R05 KED1000	192,87
119	19	73	119	19	73	APLRE3120-119-R10 KED1000	192,87
119	19	73	119	19	73	APLRE3120-119-R20 KED1000	192,87
150	25	100	150	25	100	APLRE3160-150-R10 KED1000	344,74
150	25	100	150	25	100	APLRE3160-150-R20 KED1000	344,74
150	25	100	150	25	100	APLRE3160-150-R30 KED1000	344,74

FRAISES CARBURE | EBAVUREUR 90° AVANT / ARRIÈRE

InovaTools
GERMAN TOOLS GROUP

Articles 900 ...

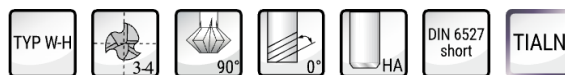

D1	D2	D3	L2	L1	D3	L3	Z	Articles	Code	Prix promo € net HT
2,00	6,00		1,40	100	1,20	10	3	90002000	363702	53,83
3,00	6,00		2,00	100	2,00	10	4	90003000	363703	53,83
4,00	6,00		3,00	100	2,00	13	4	90004000	363704	53,83
6,00	6,00		4,00	100	4,00	19	4	90006000	363705	59,21
8,00	6,00	3,60	3,20	100			4	90008000	363706	76,44
10,00	6,00	5,40	4,30	150			4	90010000	363707	93,67

FRAISES CARBURE | FRAISE 1/4 DE CERCLE AVANT/ARRIÈRE

InovaTools
GERMAN TOOLS GROUP

Articles 901 ...

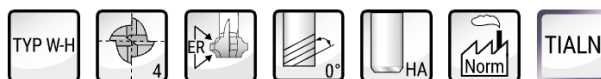

D1	D2	DS	L2	L1	ER	F	Articles	Code	Prix promo € net HT
8,00	6,00	7,60	3	100	0,20	4	90108000	363712	124,34
8,00	6,00	7,40	3	100	0,30	4	90108100	363713	124,34
8,00	6,00	7,20	3	100	0,40	4	90108200	363714	124,34
8,00	6,00	7,00	3	100	0,50	4	90108300	363715	124,34
10,00	6,00	8,40	4	100	0,80	4	90108400	363716	130,27
10,00	6,00	8,00	4	100	1,00	4	90108500	363717	130,27
10,00	6,00	7,60	4	100	1,20	4	90108600	363718	130,27
10,00	6,00	7,00	4	100	1,50	4	90108700	363719	130,27

FRAISES CARBURE | FRAISES À FILETER

INCONEL | TITANE | INOX | ACIER | ALUMINIUM



M	M FIN	UNC UNF	d	D	Z	I	L	1 DENT		2 DENTS	
								Code	Prix promo € net HT	Code	Prix promo € net HT
M2	0,35 - 0,40	N°2 (2,0xD)	4	1,50	4	4,4	50	093161	61,79	093143	73,66
M2	0,35 - 0,40	N°2 (3,0xD)	4	1,50	4	6,4	50	093162	67,57	093144	81,00
M2,2	0,45	N°2 (2,0xD)	4	1,65	4	5	50	093163	61,41	093145	74,12
M2,2	0,45	N°2 (3,0xD)	4	1,65	4	7,1	50	093164	67,57	093146	81,00
M2,5	0,45 - 0,50	N°3 (2,0xD)	4	1,90	4	5,5	50	093165	61,79	093147	73,66
M2,5	0,45 - 0,50	N°3 (3,0xD)	4	2,10	4	8	50	093166	67,57	093148	81,00
		N°4 (2,0xD)	4	2,10	4	6,4	50	093167	61,41		
		N°4 (3,0xD)	4	2,10	4	9,2	50	093168	67,57		
M3	0,50 - 0,60	N°5 (2,0xD)	4	2,30	4	6,5	50	093169	61,79	093149	74,12
M3	0,50 - 0,60	N°5 (3,0xD)	4	2,30	4	9,5	50	093170	67,57	093150	81,00
M3,5	0,50 - 0,75	N°6 (2,0xD)	4	2,60	4	7,6	50	093171	61,41	093151	73,66
M3,5	0,50 - 0,75	N°6 (3,0xD)	4	2,60	4	11,1	50	093172	67,57	093152	81,00
M4	0,70 - 0,75	N°8 (2,0xD)	4	3,00	4	9	50	093173	61,79	093153	74,12
M4	0,70 - 0,75	N°8 (3,0xD)	4	3,00	4	13	50	093174	67,57	093154	81,00
M4,5	0,75 - 1,00	N°10 (2,0xD)	4	3,60	4	10	50	093175	61,41		
M4,5	0,75 - 1,00	N°10 (3,0xD)	4	3,60	4	14,3	50	093176	67,57		
M5	0,75 - 1,00	N°12 (2,0xD)	4	4,00	4	11	50	093177	61,79	093155	73,66
M5	0,75 - 1,00	N°12 (3,0xD)	4	4,00	4	16	50	093178	67,57	093156	81,00
M6	1,00	(2,0xD)	4	3,80	4	11	50			093157	87,23
M6	1,00	(3,0xD)	4	3,80	4	16	50			093158	95,88
M8	1,25	(2,0xD)	4	4,50	4	13	63			093159	87,23
M8	1,14	(3,0xD)	4	4,50	4	19	76			093160	95,88

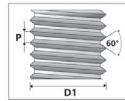
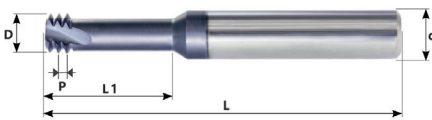

TiAIN beschichtet
TiAIN coated

Désignation	P	L	D1	d	D	L1	Z	Code	Prix promo € net HT
TMCM06024-3-6-0.5ISO	0,50	58	M3	6	2,37	6,5	3	076039	75,08
TMCM06031-3-9-0.7ISO	0,70	58	M4	6	3,10	9,0	3	076040	75,08
TMCM06038-3-12-0.8ISO	0,80	58	M5	6	3,80	12,5	3	076041	75,08
TMCM06047-3-14-1.0ISO	1,00	58	M6	6	4,65	14,0	3	076047	75,08
TMCM0606-3-18-1.25ISO	1,25	58	M8	6	6,00	18,0	3	076068	75,08
TMCM08078-3-23-1.5ISO	1,50	64	M10	8	7,80	23,0	3	076069	96,30
TMCM1009-3-26-1.75ISO	1,75	73	M12	10	9,00	26,0	3	076070	109,35
TMCM12118-4-35-2.0ISO	2,00	84	M16	12	11,80	35,0	4	076071	146,89
TMCM1615-5-43-2.5ISO	2,50	105	M20	16	15,00	43,0	5	076046	199,12

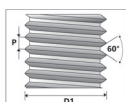
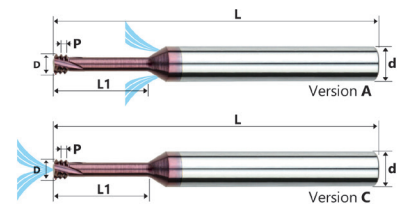

Désignation	P	L	D1	d	D	L1	Z	Prof.	Version	Code	Prix promo € net HT
TMCMC06024-4-6-0.5ISO	0,50	58	M3	6	2,40	6,5	4	2xD	A	076052	88,63
TMCMC06024-4-9-0.5ISO	0,50	58	M3	6	2,40	9,5	4	3xD	A	076053	89,14
TMCMC06032-4-8-0.7ISO	0,70	58	M4	6	3,20	8,7	4	2xD	C	076054	88,63
TMCMC06032-4-12-0.7ISO	0,70	58	M4	6	3,20	12,7	4	3xD	C	076055	98,05
TMCMC06038-4-10-0.8ISO	0,80	58	M5	6	3,80	10,8	4	2xD	C	076064	88,63
TMCMC06038-4-15-0.8ISO	0,80	58	M5	6	3,80	15,8	4	3xD	C	076065	98,05
TMCMC08048-4-13-1.0ISO	1,00	64	M6	8	4,80	13,0	4	2xD	C	076066	105,90
TMCMC08048-4-19-1.0ISO	1,00	64	M6	8	4,80	19,0	4	3xD	C	076067	105,90
TMCMC0606-4-25-1.25ISO	1,25	58	M8	6	6,00	25,3	4	3xD	C	076042	98,05
TMCMC0808-5-31-1.5ISO	1,50	64	M10	8	8,00	31,5	5	3xD	C	076043	122,59
TMCMC10095-5-37-1.75ISO	1,75	73	M12	10	9,50	37,8	5	3xD	C	076044	134,83
TMCMC1212-5-50-2.0ISO	2,00	105	M16	12	12,00	50,0	5	3xD	C	076045	177,32

FRAISES HSS | FRAISE FINITION ACIER FRITTÉ WX6 - 505

Jusqu'au Ø20

* délais sur demande



TITANE | INOX | ACIER

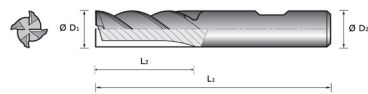

FRAISES DEUX TAILLES FINITION
SÉRIE MOYENNE

- NORME USINE
- COUPE AU CENTRE
- HÉLICE 40°

D1	L2	L1	D2	Z	Code	Prix promo € net HT	D1	L2	L1	D2	Z	Code	Prix promo € net HT
3	8	52	6	4	015597	14,44	15*	36	96	16	4	015618	38,89
4	11	55	6	4	015598	14,44	16	36	96	16	4	015608	38,89
5	13	57	6	4	015599	14,44	17*	40	100	16	4	015609	42,78
6	16	60	6	4	015600	14,44	18	40	100	16	4	015610	42,78
7	22	72	10	4	015601	22,22	19*	45	105	16	4	015611	50,00
8	25	75	10	4	015602	22,22	20	45	111	20	4	015612	51,67
9	25	75	10	4	015603	22,22	22*	46	111	20	5	015613	68,33
10	28	78	10	4	015604	22,22	25	50	126	25	5	015614	82,22
11*	28	85	12	4	015605	28,89	30*	63	139	25	6	015615	123,49
12	32	89	12	4	015606	28,89	32	63	143	32	6	015616	138,49
13*	32	89	12	4	015607	33,89							
14	32	92	16	4	015617	37,78							

FRAISES HSS | FRAISE D'ÉBAUCHE ACIER FRITTÉ WX6 - 630C - 635C

Jusqu'au Ø20

* délais sur demande



TITANE | INOX | ACIER

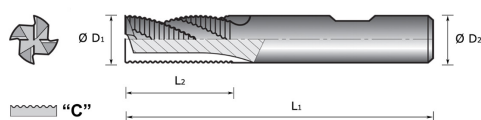

FRAISES RAVAGEUSES DEUX TAILLES
SÉRIE MOYENNE

- NORME USINE
- COUPE AU CENTRE
- HÉLICE 30°

D1	L2	L1	D2	Z	Code	Prix promo € net HT
6	13	57	6	3	015530	25,00
8	19	69	10	3	015532	33,89
10	22	72	10	3	015534	33,89
12	26	83	12	3	015536	37,78
14	26	83	12	4	015538	38,07
16	32	92	16	4	015540	47,78
18	32	92	16	4	015541	61,64
20	38	104	20	4	015543	57,22
25	45	121	25	4	015544	92,78

D1	L2	L1	D2	Z	Code	Prix promo € net HT
6	16	60	6	3	015690	25,00
7	22	72	10	3	015691	33,89
8	25	75	10	3	015692	33,89
9	25	75	10	4	015693	33,89
10	28	78	10	4	015694	33,89
11	28	85	12	4	015695	37,78
12	32	89	12	4	015696	37,78
13	32	89	12	4	015697	41,67
14	32	92	16	4	015698	47,78
15*	36	96	16	4	015699	47,78
16	36	96	16	4	015700	47,78
17*	40	100	16	4	015701	52,78
18	40	100	16	4	015702	52,78
19*	45	105	16	4	015703	57,22
20	45	111	20	4	015704	57,22
22*	45	111	20	4	015705	71,67
25	50	126	25	5	015706	88,89
26*	56	132	25	5	015709	123,49
30*	63	139	25	5	015707	136,27
32	63	143	32	5	015708	152,38
35*	63	143	32	6	015710	222,94
36*	63	143	32	6	015711	252,38

FRAISES RAVAGEUSES DEUX TAILLES
SÉRIE MOYENNE

- NORME USINE
- COUPE AU CENTRE
- HÉLICE 30°

FRAISES A CHANFREINER | COFFRET HSSE-E ULTIMATECUT



Diamètre	Désignation	Référence	Code	Prix promo € net HT
1 - 5,9	Coffret 50 forets HSS taillé Meulé Progression 0,1	214217	020819	71,78
6 - 10	Coffret 41 forets HSS Taillé Meulé Progression 0,1	214218	020820	160,91
1 - 13	Jeu de 25 forets Co5 - coffret ABS Progression 0,5	259215ERO	020821	222,31
1 - 5,9	Coffret 50 forets Co5 Progression 0,1	215217RO	020822	102,68
6 - 10	Coffret 41 forets Co5 Progression 0,1	215218	020823	249,73

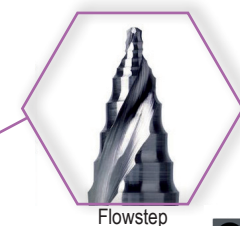

Flowstep



FRAISES A CHANFREINER



Articles 431 ...



90°



D1	ANGLE	HSS E	
		Code	Prix € HT
4,30	90°	011860	8,45
5,00	90°	011861	8,45
6,00	90°	011863	8,67
6,30	90°	011864	8,67
8,00	90°	011865	9,71
8,30	90°	011866	10,00
10,00	90°	011867	11,21
10,40	90°	011868	11,57
11,50	90°	011869	12,60
12,40	90°	011870	12,74
15,00	90°	011871	14,03
16,50	90°	011872	14,91
20,50	90°	011874	21,78
25,00	90°	011876	30,10
31,00	90°	011878	42,19

D	d1	d2	L	Code	Prix promo € net HT
4,30	1,30	4	40	013330	11,50
5,00	1,50	4	40	013332	11,50
5,30	1,50	4	40	013333	11,50
6,00	1,50	5	45	013335	11,50
6,30	1,50	5	45	013336	11,50
8,00	2,00	6	50	013339	13,12
8,30	2,00	6	50	013340	13,12
9,40	2,20	6	50	013341	15,47
10,00	2,50	6	50	013342	15,47
10,40	2,50	6	50	013343	15,47
11,50	2,80	8	56	013344	18,11
12,40	2,80	8	56	013345	18,11
14,40	2,90	8	56	013346	23,17
15,00	3,20	10	60	013347	23,17
16,50	3,20	10	60	013348	23,17
19,00	3,50	10	63	013349	29,90
20,50	3,50	10	63	013350	29,90
25,00	3,80	10	67	013352	38,94
30,00	4,20	12	71	013355	57,95
31,00	4,20	12	71	013356	57,95
35,00	4,50	Morse 2	133	013353	91,47
37,00	4,50	Morse 2	145	013357	110,49

| AUTRES DIAMÈTRES DISPONIBLES SUR DEMANDE |

FRAISES A CHANFREINER | YT

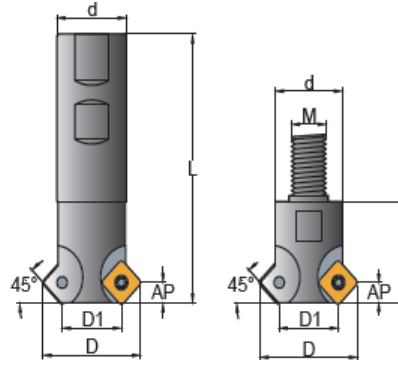

**REMISE 20%
À DÉDUIRE**

D	D1	d	L	AP	M	Z	INSERT	SCREW	KEY	Articles	Prix tarif € HT
18	11	12	90	3		2	SD 06	C025045	T08P	MC 1218	141,52
25	19	16	100	3		3	SD 06	C025045	T08P	MC 1625	145,45
32	22	20	100	6		2	SD 09	C04011	T15P	MC 2032	157,49
18	11	11	20	3	6	2	SD 06	C025045	T08P	HMC 18	133,66
25	19	15	30	3	8	3	SD 06	C025045	T08P	HMC 25	137,59
32	22	19	30	6	10	2	SD 09	C04011	T15P	HMC 32	149,23

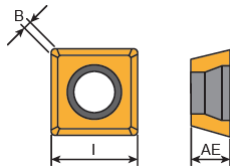

I	AE	B	Articles	Cdtnmt.	Prix tarif € HT
6,00	2,30	1,0	SDET060208N ME B100	10	12,32
9,00	3,97	1,2	SDET09T308TN M B100	10	13,55
9,00	3,97	1,2	SDET09T308TN ME B100	10	13,55

**Déconditionnement
Majoration 15 %**

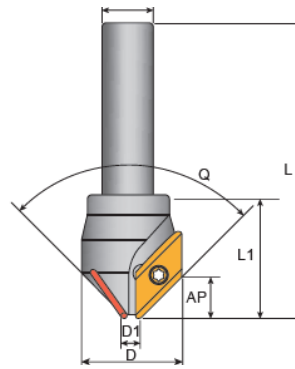

D1	D	d	L	AP	L1	Q	INSERT	SCREW	KEY	Articles	Prix tarif € HT
7,00	17,00	10,00	65,00	8,50	27,00	60°	XDGT120308	C03506	T10P	CI 17 60°	157,55
15,50	31,00	12,00	78,00	13,00	35,00	60°	XDGT19408	C04011	T15P	CI 31 60°	214,35
4,00	10,00	10,00	60,00	3,00	14,00	90°	ADGT060204	C01804	T06P	CI 12 90°	139,19
4,00	10,00	10,00	90,00	3,00	14,00	90°	ADGT060204	C01804	T06P	CI 12 90° L	143,90
5,50	22,00	10,00	65,00	8,00	27,00	90°	XDGT12308	C03506	T10P	CI 22 90°	157,55
15,00	36,00	12,00	78,00	10,00	38,00	90°	XDGT19408	C04011	T15P	CI 36 90°	226,80

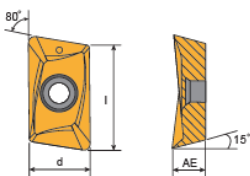

I	d	AE	Articles	Cdtnmt.	Prix tarif € HT
12,00	8,50	3,18	XDGT120308TR ME C B100	10	22,80
19,00	10,60	4,76	XDGT190408TR ME B100	10	29,11
40,00	10,60	4,76	XDGT400408TR ME B100	2	59,06
6,95	4,05	24,00	ADGT060204TR ME C B100	10	19,08

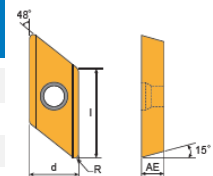

**Déconditionnement
Majoration 15 %**

| TARIF ACTUEL EN VIGUEUR |

FRAISES SCIES | YT - PLAQUETTES GAMME UFO



3T

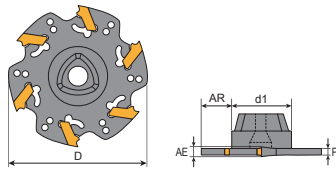

3T

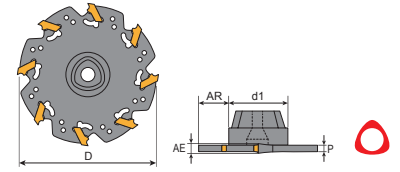

Order Code	Dimensions (mm)					Z	⊖ /KG	MAX RPM	Inserts LNGT	Wrench
	D	d1	AR	AE	P					
3T2560-14	60	25	17	1.4	1.2	6	0.09	6500	1414	150.10-30
3T2560-16				1.5					1415	
3T2560-18				1.6	1616					
3T2560-2.0				1.8	1818					
3T2560-2.5				2.0	2020					
3T2560-3.0				2.2	2222					
3T2560-4.0				2.5	2525					
3T2560-5.0				2.7	2727					
				3.0	3030					
				3.2	3032					
	3.5	3035								
	4.0	4040								
	4.2	4042								
	4.5	4045								
	5.0	5050								
	5.2	5052								
	5.5	5055								

*Wrench for above holders sold separately.

Order Code	Dimensions (mm)					Z	⊖ /KG	MAX RPM	Inserts LNGT	Wrench
	D	d1	AR	AE	P					
3T2580-1.4	80	25	27	1.4	1.2	8	0.11	6500	1414	150.10-30
3T2580-1.6				1.5					1415	
3T2580-1.8				1.6	1616					
3T2580-2.0				1.8	1818					
3T2580-2.5				2.0	2020					
3T2580-3.0				2.2	2222					
3T2580-4.0				2.5	2525					
3T2580-5.0				2.7	2727					
				3.0	3030					
				3.2	3032					
	3.5	3035								
	4.0	4040								
	4.2	4042								
	4.5	4045								
	5.0	5050								
	5.2	5052								
	5.5	5055								

*Wrench for above holders sold separately.

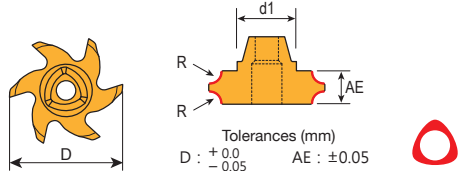
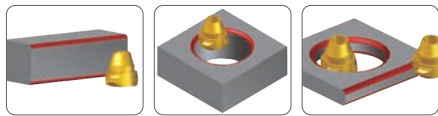

Dimensions (mm)				
D	d1	AE	R	Max. AR
19.8	9.9	3.0	0.5	0.5
		3.5	0.75	0.75
		4.0	1.0	1.0
		4.5	1.25	1.25
		5.0	1.5	1.5
		6.0	2.0	2.0

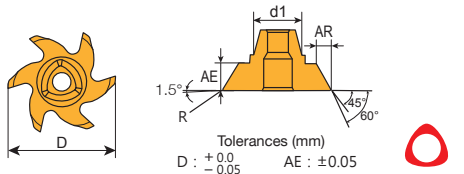

Dimensions (mm)					
D	d1	AE	Angle	Max. AR	R
20	9.9	5.0	45°	3.0	0.4
			60°	2.5	

Inserts	Order Code
	3T0610-DCR0.5-ME
	3T0612-DCR0.5-ME
	3T0612-DCR1.0-ME
	3T0612-DCR1.5-ME
	3T1020-DCR0.5-ME
	3T1020-DCR0.75-ME
	3T1020-DCR1.0-ME
	3T1020-DCR1.25-ME
	3T1020-DCR1.5-ME
	3T1020-DCR2.0-ME

Inserts	Order Code
	3T1020-45-E
	3T1020-60-E
	3T1020-45-ME
	3T1020-60-ME

Order code	Dimensions (mm)					Design	⊖ /KG	Inserts
	D	d	L	L1	Q			
CB3-0808-55-15	7.9	8	55	10	-	2	0.08	∅13
CB3-1010-90-15	9.9	10	90					

Order code	Dimensions (mm)					Design	⊖ /KG	Inserts	Screw	Key
	D	d	L	L1	Q					
CB3W-1208-110-15	7.9	12	110	30	1°	3	0.21	C03012	T09P	
CB3W-1210-120-15	9.9		120				0.24			

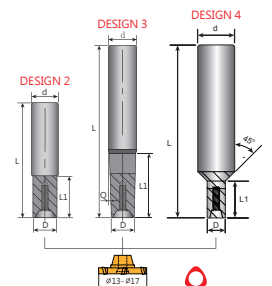
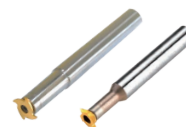

FRAISES SCIES | GAMME SBL-STL-BL/BLL

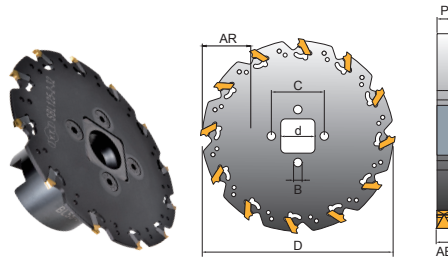

SBL

Order Code	Dimensions (mm)							Z	H	KG	MAX. RPM	Inserts LNGT	Wrench	
	D	AE	AR	P	d	C	B							
SBL080-1.8-22	80	1.8	17	1.6	22	34	5	8	-	0.10	8000	1818	150.10-30	
SBL100-1.8-22	100		27					10		0.15	6300			
SBL125-1.8-32	125		33					12		0.21	5000			
SBL160-1.8-32	160		50.5					16		0.37	4000			
SBL080-2-22	80	2.0	17	1.75	22	34	5	8	-	0.10	8000	2020 2022 2025	150.10-30	
SBL100-2-22	100		27					10		0.15	6300			
SBL125-2-32	125		2.2					33		12	0.22			5000
SBL160-2-32	160		2.5					50.5		16	0.39			4000
SBL080-2.5-22	80	2.5	17	2.25	22	34	5	8	-	0.11	8000	2525 2527 2530	150.10-30	
SBL100-2.5-22	100		27					10		0.17	6300			
SBL125-2.5-32	125		2.7					33		12	0.26			5000
SBL160-2.5-32	160		3.0					50.5		16	0.45			4000
SBL080-3-22	80	3.0	17	2.7	22	34	5	8	-	0.12	8000	3030 3032 3035	150.10-30	
SBL100-3-22	100		27					10		0.20	6300			
SBL125-3-32	125		3.2					33		12	0.29			5000
SBL160-3-32	160		3.5					50.5		16	0.51			4000
SBL080-4-22	80	4.0	17	3.7	22	34	5	8	-	0.15	8000	4040 4042 4045	150.10-30	
SBL100-4-22	100		27					10		0.24	6300			
SBL125-4-32	125		4.2					33		12	0.36			5000
SBL160-4-32	160		4.5					50.5		16	0.64			4000
SBL080-5-22	80	5.0	17	4.5	22	34	5	8	-	0.17	8000	5050 5052 5055	150.10-30	
SBL100-5-22	100		27					10		0.27	6300			
SBL125-5-32	125		5.2					33		12	0.42			5000
SBL160-5-32	160		5.5					50.5		16	0.74			4000

* Wrench for above holders sold separately.

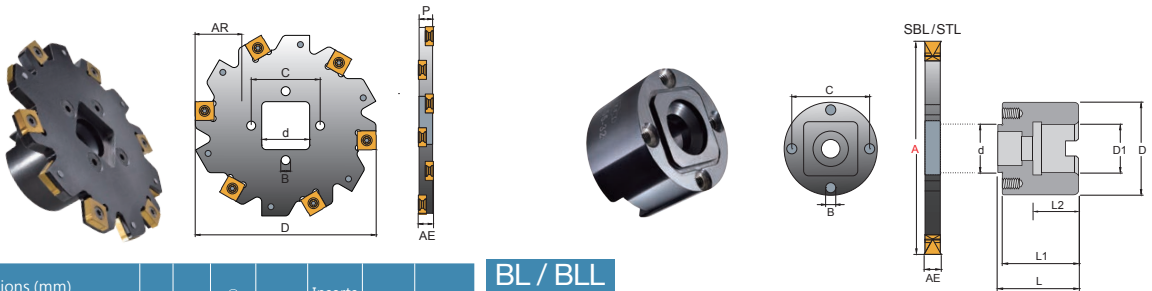

STL

Order Code	Dimensions (mm)							Z	Zc	KG	MAX. RPM	Inserts SNGX SNGW	Screw	Key
	D	AE	AR	P	d	C	B							
STL080-4-22	80	4	17	3.4	22	34	5	8	4	0.16	13700	1102	T9354	T09P
STL080-5-22		5		4.2								1103	T9355	T08P
STL100-4-22	100	4	27	3.4	32	46	6	10	5	0.26	12000	1102	T9354	T09P
STL100-5-22		5		4.2								1103	T9355	T08P
STL125-4-32	125	4	33	3.4	32	46	6	12	6	0.37	10900	1102	T9354	T09P
STL125-5-32		5		4.2								1103	T9355	T08P
STL160-4-32	160	4	50.5	3.4	32	46	6	16	8	0.68	8300	1102	T9354	T09P
STL160-5-32		5		4.2								1103	T9355	T08P

* Wrench for above holders sold separately.

BL / BLL

Order Code	Dimensions (mm)									KG	Available AE	
	D	D1	d	C	B	L	L1	L2	A			
BL45-22	45	22	22	34	5	43	41.8	27	80	0.47	AE 1-2mm	
BL45-25.4		25.4				45	43.8		100			
BL58-31.75	58	31.75	32	46	6	55	53.8	28	125	0.95		
BL58-32		32				160						
BLL45-22	45	22	22	34	5	43	40.5	27	80	0.47		AE 2.5-5.5mm
BLL45-25.4		25.4				45	42.5		100			
BLL58-31.75	58	31.75	32	46	6	55	52.5	28	125	0.95		
BLL58-32		32				160						

* Please follow the step 1 - 2 - 3 to choose the cutter and holder to match: 1. Available AE 2. "d" size 3. "D1" size.



PORTE-OUTILS ET PLAQUETTES

Order Code	Dimensions (mm)						KG	Inserts	Screw	Key
	D	D1	d	L	L1	L2				
15-1616-100-R1-3	16	14	16	100	35	25	0.21	R1-3	C03511 S0404	T10P L02
15-1616-130-R1-3				130			0.27			
15-1616-100-R4-5				100			0.21	R4-5		
15-1616-130-R4-5				130			0.27			
15-2525-110-R6-8	25	22	25	110	40	30	0.44	R6-8	C04017 S0508	T15P L025
15-2525-140-R6-8				140			0.58			
15-2525-110-R9-10				110			0.44	R9-10		
15-2525-140-R9-10				140			0.58			

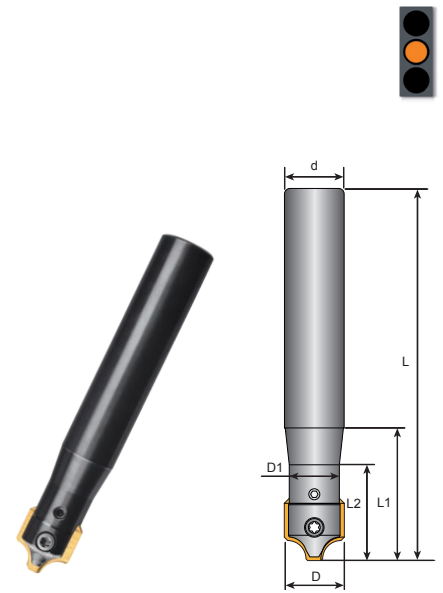

Inserts	Order Code
	25-1603-R1.0-ME
	25-1603-R1.5-ME
	25-1603-R2.0-ME
	25-1603-R2.5-ME
	25-1603-R3.0-ME
	25-1603-R4.0-ME
	25-1603-R5.0-ME
	25-2503-R6.0-ME
	25-2503-R7.0-ME
	25-2503-R8.0-ME
	25-2503-R9.0-ME
	25-2503-R10-ME

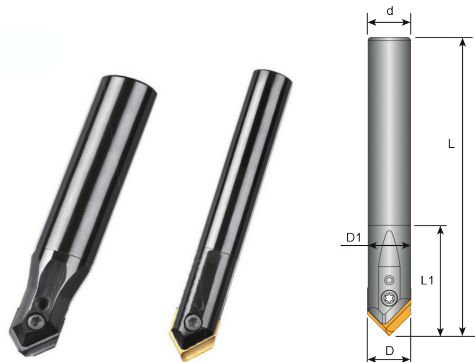

Order Code	Dimensions (mm)						KG	Inserts 23 A23 B23	Screw	Key
	D	D1	d	L	L1	L2				
13-0808-60	8	7.9	8	60	20	-	0.06	0802	C02506 S025025	T08P L013
13-0808-85				85			0.07			
13-1008-60				60			0.09			
13-1010-65	10	9.9	10	65	30	-	0.09	1002	C03008 S02503	T09P L013
13-1010-100				100			0.12			
13-1010-150				150			0.12			
13-1210-65				65			0.12			
13-1212-80	12	11.9	12	80	-	-	0.12	1203	C03010 S0304	T09P L015
13-1212-110				110			0.15			
13-1212-160				160			0.18			
13-1612-80	16	15.8	16	80	35	-	0.21	1603	C03512 S0405	T10P L02
13-1616-100				100			0.26			
13-1616-130				130			0.26			
13-1616-180				180			0.36			

23 Inserts

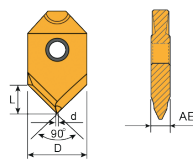

Tolerances (mm)

AE : + 0.01
- 0.02

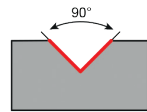

Dimensions (mm)				
D	d	L	AE	angle
8	0.7	4	2.0	90°
10	0.8	5	2.5	
12	0.9	6	3.0	
16	1.0	8	3.0	

A23 Inserts

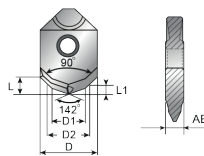

Tolerances (mm)

AE : + 0.01
- 0.02

Chamfering application

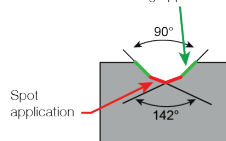

Dimensions (mm)							
D	L	D1	D2	L1	AE	M	angle
8	2.8	3.3	4.2	1.02	2.0	M4 x 0.7	90°
10	3.5	4.2	5.25	1.25	2.5	M5 x 0.8	
12	4.2	5.0	6.3	1.55	3.0	M6 x 1.0	142°
16	5.6	6.8	8.4	1.97	3.0	M8 x 1.25	
16	5.1	8.5	10.5	2.46	3.0	M10 x 1.5	

B23 Inserts

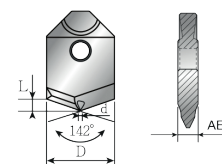

Tolerances (mm)

AE : + 0.01
- 0.02

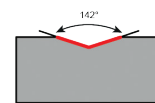

Dimensions (mm)				
D	d	L	AE	angle
8	0.7	1.28	2.0	142°
10	0.8	1.55	2.5	
12	0.9	1.86	3.0	
16	1.0	2.56	3.0	

OUTILS CARBURE MULTIFONCTIONS



MULTI-V angle 90°

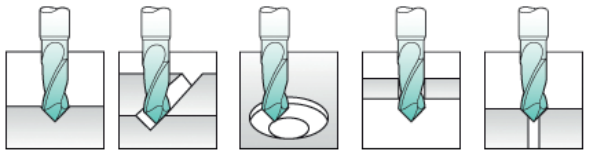

Centrage Pointage Rainurage en V Interpolation Perçage Chanfreinage

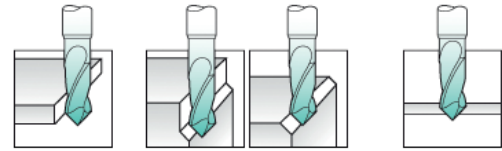

Contournage Chanfreins longitudinaux Chanfreins directs



Gravage

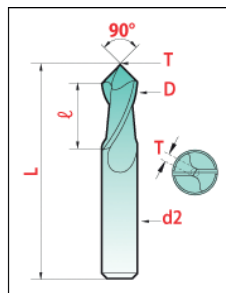

D	L	I	D2	T*	ANGLE	MULTI-V 8090		HARD'X 8090-H	
						Code	Prix promo € net HT	Code	Prix promo € net HT
0,50	39	1	3	0,05	90°				
1,00	39	2	3	0,10	90°			013978P	37,86
1,50	39	3	3	0,15	90°			013979P	37,86
2,00	39	4	3	0,20	90°	013809	33,34	013980P	37,86
2,50	39	5	3	0,25	90°			013981P	38,76
3,00	50	6	4	0,30	90°	013810	37,87	013982P	42,39
4,00	50	8	5	0,40	90°	013811	41,02	013983P	45,57
5,00	50	10	6	0,50	90°	013812	49,30		
6,00	60	12	8	0,60	90°	013813	63,47	013985P	67,99
8,00	70	16	10	0,80	90°	013814	99,71		
10,00	70	18	12	1,00	90°	013815	130,58	013987P	140,53

FRAISE À GRAVER CARBURE 60°

InovaTools
GERMAN TOOLS GROUP

Articles 745 ...

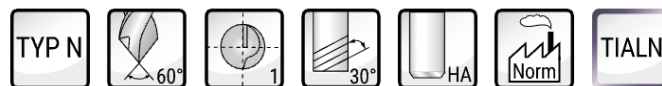

D1	D2	L2	L1	F	Articles	Code	Prix promo € net HT
3,00	3,00	2,6	40	1	74503000	363708	23,69
4,00	4,00	3,5	40	1	74504000	363709	26,06
6,00	6,00	5,2	50	1	74506000	363710	35,52

FORETS | CARBURE 3XD / 5XD À TROUS D'HUILE

InovaTools
GERMAN TOOLS GROUP

Articles 652 ...

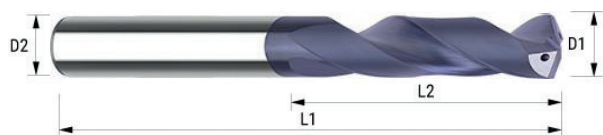

D1	D2	L2	L1	F	Articles	Code	Prix promo € net HT
3,00	6,00	20	62	2	652.030.00	272571	27,42
3,30	6,00	20	62	2	652.033.00	272572	27,42
3,50	6,00	20	62	2	652.035.00	272573	27,42
3,80	6,00	24	66	2	652.038.00	272574	27,42
4,00	6,00	24	66	2	652.040.00	272575	27,42
4,20	6,00	24	66	2	652.042.00	272576	27,42
4,50	6,00	24	66	2	652.045.00	272577	27,42
4,80	6,00	28	66	2	652.048.00	272578	27,42
5,00	6,00	28	66	2	652.050.00	272579	27,42
5,20	6,00	28	66	2	652.052.00	272580	27,42
5,50	6,00	28	66	2	652.055.00	272581	27,42
5,80	6,00	28	66	2	652.058.00	272582	27,42
6,00	6,00	28	66	2	652.060.00	272583	27,42
6,50	8,00	34	79	2	652.065.00	272584	36,31
6,80	8,00	34	79	2	652.068.00	272585	36,31
7,00	8,00	34	79	2	652.070.00	272586	36,31
7,30	8,00	41	79	2	652.073.00	272587	36,31
7,50	8,00	41	79	2	652.075.00	272588	36,31
7,80	8,00	41	79	2	652.078.00	272589	36,31
8,00	8,00	41	79	2	652.080.00	272590	36,31
8,50	10,00	47	89	2	652.085.00	272591	43,81
8,80	10,00	47	89	2	652.088.00	272592	43,81
9,00	10,00	47	89	2	652.090.00	272593	43,81

D1	D2	L2	L1	F	Articles	Code	Prix promo € net HT
9,50	10,00	47	89	2	652.095.00	272594	43,81
9,80	10,00	47	89	2	652.098.00	272595	43,81
10,00	10,00	47	89	2	652.100.00	272596	43,81
10,20	12,00	55	102	2	652.102.00	272597	64,98
10,50	12,00	55	102	2	652.105.00	272598	64,98
10,80	12,00	55	102	2	652.108.00	272599	64,98
11,00	12,00	55	102	2	652.110.00	272600	64,98
11,50	12,00	55	102	2	652.115.00	272601	64,98
11,80	12,00	55	102	2	652.118.00	272602	64,98
12,00	12,00	55	102	2	652.120.00	272603	64,98
12,50	14,00	60	107	2	652.125.00	272604	86,51
12,80	14,00	60	107	2	652.128.00	272605	86,51
13,00	14,00	60	107	2	652.130.00	272606	86,51
13,50	14,00	60	107	2	652.135.00	272607	86,51
13,80	14,00	60	107	2	652.138.00	272608	86,51
14,00	14,00	60	107	2	652.140.00	272609	86,51
14,50	16,00	65	115	2	652.145.00	272610	102,79
14,80	16,00	65	115	2	652.148.00	272611	102,79
15,00	16,00	65	115	2	652.150.00	272612	102,79
15,20	16,00	65	115	2	652.152.00	272613	102,79
15,50	16,00	65	115	2	652.155.00	272614	102,79
15,80	16,00	65	115	2	652.158.00	272615	102,79
16,00	16,00	65	115	2	652.160.00	272616	102,79

Articles 705 ...

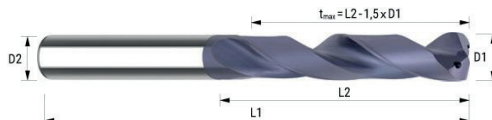

FORETS CARBURE POUR TROU DE GUIDAGE
POUR PERÇAGE PROFOND



D1	D2	L2	L1	Référence	Code	Prix promo HA € net HT
1,00	3,00	10	55	705.010...	270955	33,96
1,10	3,00	12	55	705.011...	270956	33,96
1,20	3,00	12	55	705.012...	270957	33,96
1,30	3,00	12	55	705.013...	270958	33,96
1,40	3,00	12	55	705.014...	270959	33,96
1,50	3,00	12	55	705.015...	270960	33,96
1,60	3,00	16	55	705.016...	270961	33,96
1,70	3,00	16	55	705.017...	270962	33,96
1,80	3,00	16	55	705.018...	270963	33,96
1,90	3,00	16	55	705.019...	270964	33,96
2,00	3,00	21	57	705.020...	2700011	33,33
2,02	3,00	16	57	705.202...	2700012	31,19
2,10	3,00	21	57	705.021...	270966	33,33
2,20	3,00	21	57	705.022...	270967	33,33
2,22	3,00	21	57	705.222...	2700015	31,19
2,30	3,00	21	57	705.023...	270968	33,33
2,32	3,00	21	57	705.232...	2700017	31,19
2,40	3,00	21	57	705.024...	270969	33,33
2,42	3,00	21	57	705.242...	2700019	31,19
2,50	3,00	21	57	705.025...	270970	33,26
2,52	3,00	21	57	705.252...	2700021	31,19
2,60	3,00	21	57	705.026...	2700022	33,26
2,70	3,00	21	57	705.027...	270972	33,26
2,72	3,00	21	57	705.272...	2700024	31,12
2,75	3,00	21	57	705.275...	2700025	31,12
2,80	3,00	21	57	705.028...	270973	33,26
2,82	3,00	21	57	705.282...	2700027	31,12
2,90	3,00	21	57	705.029...	270974	33,26

D1	D2	L2	L1	Référence	Code	Prix promo HA € net HT	Code	Prix promo HB € net HT
3,02	6,00	28	66	705.302...	2700029	28,67	2700030	28,67
3,22	6,00	28	66	705.322...	2700031	28,67	2700032	28,67
3,32	6,00	28	66	705.332...	2700033	28,67	2700034	28,67
3,52	6,00	28	66	705.352...	2700035	28,67	2700036	28,67
3,82	6,00	36	74	705.382...	2700037	31,08	2700038	31,08
4,02	6,00	36	74	705.402...	2700039	33,35	2700040	33,35
4,22	6,00	36	74	705.422...	2700041	33,35	2700042	33,35
4,52	6,00	36	74	705.452...	2700043	34,16	2700044	34,14
4,82	6,00	44	82	705.482...	2700045	37,22	2700046	37,22
5,02	6,00	44	82	705.502...	2700047	34,76	2700048	34,76
5,52	6,00	44	82	705.552...	2700049	34,76	2700050	34,76
5,82	6,00	44	82	705.582...	2700051	34,76	2700052	34,76
6,02	6,00	44	82	705.602...	2700053	37,03	2700054	37,03
6,52	8,00	53	91	705.652...	2700055	50,09	2700056	50,09
6,82	8,00	53	91	705.682...	2700057	50,09	2700058	50,09
7,02	8,00	53	91	705.702...	2700059	52,47	2700060	52,47
7,52	8,00	53	91	705.752...	2700061	52,47	2700062	52,47
7,82	8,00	53	91	705.782...	2700063	52,47	2700064	52,47
8,02	8,00	53	91	705.802...	2700065	54,00	2700066	54,00
8,52	8,00	61	103	705.852...	2700067	63,40	2700068	63,40
8,82	10,00	61	103	705.882...	2700069	63,40	2700070	63,40
9,02	10,00	61	103	705.902...	2700071	63,40	2700072	63,40
9,82	10,00	61	103	705.982...	2700073	64,20	2700074	64,20
10,02	10,00	61	103	705.983...	2700075	66,25	2700076	66,25
10,22	12,00	71	118	705.984...	2700077	88,41	2700078	88,41
10,82	12,00	71	118	705.985...	2700079	88,41	2700080	88,41
11,82	12,00	71	118	705.986...	2700081	90,84	2700082	90,84
12,02	12,00	71	118	705.987...	2700083	92,52	2700084	92,52

FORETS | HÉLICOÏDAUX CARBURE MONOBLOC HPC 5D



INCONEL | TITANE | INOX | ACIER | ALUMINIUM | FONTE

Articles 845 ...

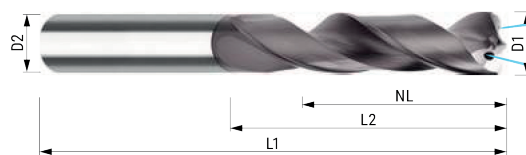

D1	D2	L2	L1	NL	Code	Prix promo € net HT	D1	D2	L2	L1	NL	Code	Prix promo € net HT	D1	D2	L2	L1	NL	Code	Prix promo € net HT	
3,00	6	28	66	23	272150	30,39	6,80	8	53	91	43	272189	36,76	10,70	12	71	118	56	272228	60,16	
3,10	6	28	66	23	272151	30,39	6,90	8	53	91	43	272190	36,76	10,80	12	71	118	56	272229	60,16	
3,20	6	28	66	23	272152	30,39	7,00	8	53	91	43	272191	36,76	10,90	12	71	118	56	272230	60,16	
3,30	6	28	66	23	272153	30,39	7,10	8	53	91	43	272192	36,76	11,00	12	71	118	56	272231	60,16	
3,40	6	28	66	23	272154	30,39	7,20	8	53	91	43	272193	36,76	11,10	12	71	118	56	272232	60,16	
3,50	6	28	66	23	272155	30,39	7,30	8	53	91	43	272194	36,76	11,20	12	71	118	56	272233	60,16	
3,60	6	28	66	23	272156	30,39	7,40	8	53	91	43	272195	36,76	11,30	12	71	118	56	272234	60,16	
3,70	6	28	66	23	272157	30,39	7,50	8	53	91	43	272196	36,76	11,40	12	71	118	56	272235	60,16	
3,80	6	36	74	29	272158	30,39	7,60	8	53	91	43	272197	36,76	11,50	12	71	118	56	272236	60,16	
3,90	6	36	74	29	272159	30,39	7,70	8	53	91	43	272198	36,76	11,60	12	71	118	56	272237	60,16	
4,00	6	36	74	29	272160	30,39	7,80	8	53	91	43	272199	36,76	11,70	12	71	118	56	272238	60,16	
4,10	6	36	74	29	272161	30,39	7,90	8	53	91	43	272200	36,76	11,80	12	71	118	56	272239	60,16	
4,20	6	36	74	29	272162	30,39	8,00	8	53	91	43	272201	36,76	11,90	12	71	118	56	272240	60,16	
4,30	6	36	74	29	272163	30,39	8,10	10	61	103	49	272202	45,72	12,00	12	71	118	56	272241	60,16	
4,40	6	36	74	29	272164	30,39	8,20	10	61	103	49	272203	45,72	12,20	14	77	124	60	272242	89,01	
4,50	6	36	74	29	272165	30,39	8,30	10	61	103	49	272204	45,72	12,30	14	77	124	60	272243	89,01	
4,60	6	36	74	29	272166	30,39	8,40	10	61	103	49	272205	45,72	12,50	14	77	124	60	272244	89,01	
4,65	6	36	74	29	272167	50,58	8,50	10	61	103	49	272206	45,72	12,80	14	77	124	60	272245	89,01	
4,70	6	36	74	29	272168	30,39	8,60	10	61	103	49	272207	45,72	13,00	14	77	124	60	272246	89,01	
4,80	6	44	82	35	272169	30,39	8,70	10	61	103	49	272208	45,72	13,50	14	77	124	60	272247	89,01	
4,90	6	44	82	35	272170	30,39	8,80	10	61	103	49	272209	45,72	13,80	14	77	124	60	272248	89,01	
5,00	6	44	82	35	272171	30,39	8,90	10	61	103	49	272210	45,72	14,00	14	77	124	60	272249	89,01	
5,10	6	44	82	35	272172	30,39	9,00	10	61	103	49	272211	45,72	14,50	16	83	133	63	272250	109,24	
5,20	6	44	82	35	272173	30,39	9,10	10	61	103	49	272212	45,72	14,80	16	83	133	63	272251	109,24	
5,30	6	44	82	35	272174	30,39	9,20	10	61	103	49	272213	45,72	15,00	16	83	133	63	272252	109,24	
5,40	6	44	82	35	272175	30,39	9,30	10	61	103	49	272214	45,72	15,50	16	83	133	63	272253	109,24	
5,50	6	44	82	35	272176	30,39	9,40	10	61	103	49	272215	45,72	15,80	16	83	133	63	272254	109,24	
5,60	6	44	82	35	272177	30,39	9,50	10	61	103	49	272216	45,72	16,00	16	83	133	63	272255	109,24	
5,70	6	44	82	35	272178	30,39	9,60	10	61	103	49	272217	45,72	16,50	18	93	143	71	272256	149,69	
5,80	6	44	82	35	272179	30,39	9,70	10	61	103	49	272218	45,72	16,80	18	93	143	71	272257	149,69	
5,90	6	44	82	35	272180	30,39	9,80	10	61	103	49	272219	45,72	17,00	18	93	143	71	272258	149,69	
6,00	6	44	82	35	272181	30,39	9,90	10	61	103	49	272220	45,72	17,50	18	93	143	71	272259	149,69	
6,10	8	53	91	43	272182	36,76	10,00	10	61	103	49	272221	45,72	17,80	18	93	143	71	272260	149,69	
6,20	8	53	91	43	272183	36,76	10,10	12	71	118	56	272222	60,16	18,00	18	93	143	71	272261	149,69	
6,30	8	53	91	43	272184	36,76	10,20	12	71	118	56	272223	60,16	18,50	18	93	143	71	272262	190,14	
6,40	8	53	91	43	272185	36,76	10,30	12	71	118	56	272224	60,16	19,00	18	93	143	71	272263	190,14	
6,50	8	53	91	43	272186	36,76	10,40	12	71	118	56	272225	60,16	19,50	18	93	143	71	272264	190,14	
6,60	8	53	91	43	272187	36,76	10,50	12	71	118	56	272226	60,16	20,00	18	93	143	71	272265	190,14	
6,70	8	53	91	43	272188	36,76	10,60	12	71	118	56	272227	60,16								

Le saviez-vous ?

Existe aussi en queue Weldon



FORETS | HÉLICOÏDAUX CARBURE MONOBLOC 8D



Articles 708 ...

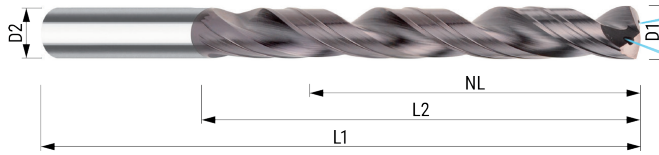

D1M7	D2H6	L1	L2	NL	Code	Prix promo € net HT	D1M7	D2H6	L1	L2	NL	Code	Prix promo € net HT
1,00	3,00	55	11	9,00	270190	38,90	7,00	8,00	114	76	60,00	270710	95,29
1,10	3,00	55	17	13,50	270191	38,90	7,10	8,00	114	76	60,00	270711	95,29
1,20	3,00	55	17	13,50	270192	38,90	7,20	8,00	114	76	60,00	270712	95,29
1,30	3,00	55	17	13,50	270193	38,90	7,30	8,00	114	76	60,00	270713	95,29
1,40	3,00	55	17	13,50	270194	38,90	7,40	8,00	114	76	60,00	270714	95,29
1,50	3,00	55	17	13,50	270195	38,90	7,50	8,00	114	76	60,00	270715	97,22
1,60	3,00	65	22	17,50	270196	38,90	7,60	8,00	114	76	60,00	270716	97,22
1,70	3,00	65	22	17,50	270197	38,90	7,70	8,00	114	76	60,00	270717	102,97
1,80	3,00	65	22	17,50	270198	38,90	7,80	8,00	114	76	60,00	270718	102,97
1,90	3,00	65	22	17,50	270199	38,90	7,90	8,00	114	76	60,00	270719	102,97
2,00	3,00	74	28	22,50	270411	40,47	8,00	8,00	114	76	60,00	270720	101,04
2,10	3,00	74	28	22,50	270412	40,47	8,10	10,00	142	95	68,00	270721	131,49
2,20	3,00	74	28	22,50	270413	40,47	8,20	10,00	142	95	68,00	270722	131,49
2,30	3,00	74	28	22,50	270414	40,47	8,30	10,00	142	95	68,00	270723	131,49
2,40	3,00	74	28	22,50	270415	40,47	8,40	10,00	142	95	68,00	270724	131,49
2,50	3,00	74	28	22,50	270416	41,76	8,50	10,00	142	95	68,00	270725	131,49
2,60	3,00	81	32	22,50	270417	41,76	8,60	10,00	142	95	68,00	270726	131,49
2,70	3,00	81	32	22,50	270418	41,76	8,70	10,00	142	95	68,00	270727	131,49
2,80	3,00	81	32	22,50	270419	41,76	8,80	10,00	142	95	68,00	270728	131,49
2,90	3,00	81	32	22,50	270420	41,76	8,90	10,00	142	95	68,00	270729	131,49
3,00	6,00	72	34	27,00	270670	51,04	9,00	10,00	142	95	68,00	270730	132,48
3,10	6,00	72	34	27,00	270671	51,04	9,10	10,00	142	95	76,00	270731	132,48
3,20	6,00	72	34	27,00	270672	51,04	9,20	10,00	142	95	76,00	270732	132,48
3,30	6,00	72	34	27,00	270673	51,04	9,30	10,00	142	95	76,00	270733	132,48
3,40	6,00	72	34	27,00	270674	51,04	9,40	10,00	142	95	76,00	270734	132,48
3,50	6,00	72	34	27,00	270675	51,04	9,50	10,00	142	95	76,00	270735	133,45
3,60	6,00	72	34	27,00	270676	52,00	9,60	10,00	142	95	76,00	270736	133,45
3,70	6,00	72	34	27,00	270677	52,00	9,70	10,00	142	95	76,00	270737	134,50
3,80	6,00	86	43	35,00	270678	53,85	9,80	10,00	142	95	76,00	270738	134,50
3,90	6,00	86	43	35,00	270679	53,85	9,90	10,00	142	95	76,00	270739	134,50
4,00	6,00	86	43	35,00	270680	54,83	10,00	10,00	142	95	76,00	270740	139,40
4,10	6,00	86	43	35,00	270681	56,68	10,10	12,00	162	114	90,00	270741	177,52
4,20	6,00	86	43	35,00	270682	56,68	10,20	12,00	162	114	90,00	270742	177,52
4,30	6,00	86	43	35,00	270683	56,68	10,30	12,00	162	114	90,00	270743	178,53
4,40	6,00	86	43	35,00	270684	56,68	10,40	12,00	162	114	90,00	270744	178,53
4,50	6,00	86	43	35,00	270685	58,57	10,50	12,00	162	114	90,00	270745	179,52
4,60	6,00	86	43	35,00	270686	62,36	10,60	12,00	162	114	90,00	270746	179,52
4,70	6,00	86	43	35,00	270687	74,43	10,70	12,00	162	114	90,00	270747	180,55
4,80	6,00	95	57	45,00	270688	62,36	10,80	12,00	162	114	90,00	270748	180,55
4,90	6,00	95	57	45,00	270689	64,25	10,90	12,00	162	114	90,00	270749	180,55
5,00	6,00	95	57	45,00	270690	64,25	11,00	12,00	162	114	90,00	270750	181,54
5,10	6,00	95	57	45,00	270691	64,25	11,10	12,00	162	114	90,00	270751	181,54
5,20	6,00	95	57	45,00	270692	64,25	11,20	12,00	162	114	90,00	270752	182,53
5,30	6,00	95	57	45,00	270693	64,25	11,30	12,00	162	114	90,00	270753	182,53
5,40	6,00	95	57	45,00	270694	64,25	11,40	12,00	162	114	90,00	270754	182,53
5,50	6,00	95	57	45,00	270695	64,25	11,50	12,00	162	114	90,00	270755	183,54
5,60	6,00	95	57	45,00	270696	64,25	11,60	12,00	162	114	90,00	270756	183,54
5,70	6,00	95	57	45,00	270697	64,25	11,70	12,00	162	114	90,00	270757	184,53
5,80	6,00	95	57	45,00	270698	65,19	11,80	12,00	162	114	90,00	270758	184,53
5,90	6,00	95	57	45,00	270699	68,95	11,90	12,00	162	114	90,00	270759	184,53
6,00	6,00	95	57	45,00	270700	68,95	12,00	12,00	162	114	90,00	270760	185,49
6,10	8,00	114	76	52,00	270701	90,45	12,50	14,00	184	133	106,00	270421	264,01
6,20	8,00	114	76	52,00	270702	94,36	12,80	14,00	184	133	106,00	270422	264,01
6,30	8,00	114	76	52,00	270703	94,36	13,00	14,00	184	133	106,00	270423	264,01
6,40	8,00	114	76	52,00	270704	94,36	13,50	14,00	184	133	106,00	270424	264,01
6,50	8,00	114	76	52,00	270705	95,29	14,00	14,00	184	133	106,00	270425	264,01
6,60	8,00	114	76	52,00	270706	95,29	14,50	16,00	203	152	122,00	270426	355,57
6,70	8,00	114	76	52,00	270707	95,29	15,00	16,00	203	152	122,00	270427	355,57
6,80	8,00	114	76	52,00	270708	95,29	15,50	16,00	203	152	122,00	270428	355,57
6,90	8,00	114	76	52,00	270709	95,29	16,00	16,00	203	152	122,00	270429	355,57

Le saviez-vous ?

Inovatools fait des micros forets :



Famille 506 - Ø 0,1 - 3,0 par incrément de 0,05
3xD non revetue

Famille 507 - Ø 0,1 - 3,0 par incrément de 0,01
5xD revetue

Famille 508 - Ø 0,1 - 2,05 par incrément de 0,01
8xD non revetue

FORETS | CARBURE 12xD À TROUS D'HUILE



Articles 710 ...

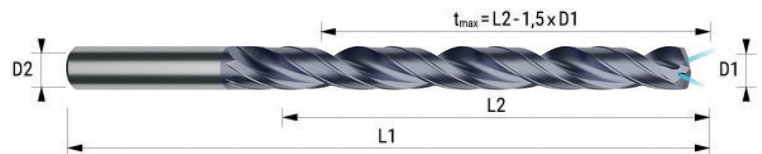

D1	D2	L2	L1	Articles	Code	Prix promo € net HT	D1	D2	L2	L1	Articles	Code	Prix promo € net HT	D1	D2	L2	L1	Articles	Code	Prix promo € net HT
1,00	3,00	15	55	71001000	270890	51,73	3,30	6,00	54	92	71003300	270911	88,68	9,00	10,00	120	162	71009000	270930	210,98
1,10	3,00	23	55	71001100	270891	51,73	3,50	6,00	54	92	71003500	270912	88,68	9,50	10,00	120	162	71009500	270931	210,98
1,20	3,00	23	55	71001200	270892	51,73	3,80	6,00	64	102	71003800	270913	90,23	9,80	10,00	120	162	71009800	270932	210,98
1,30	3,00	23	55	71001300	270893	51,73	4,00	6,00	64	102	71004000	270914	90,23	10,00	10,00	120	162	71010000	270933	210,98
1,40	3,00	23	55	71001400	270894	51,73	4,20	6,00	64	102	71004200	270915	90,23	10,20	12,00	156	204	71010200	270934	291,00
1,50	3,00	30	65	71001500	270895	51,73	4,50	6,00	64	102	71004500	270916	90,23	10,50	12,00	156	204	71010500	270935	291,00
1,60	3,00	30	65	71001600	270896	51,73	4,80	6,00	78	118	71004800	270917	92,82	10,80	12,00	156	204	71010800	270936	291,00
1,70	3,00	30	65	71001700	270897	51,73	5,00	6,00	78	118	71005000	270918	92,82	11,00	12,00	156	204	71011000	270937	291,00
1,80	3,00	30	65	71001800	270898	51,73	5,50	6,00	78	118	71005500	270919	92,82	11,50	12,00	156	204	71011500	270938	291,00
1,90	3,00	30	65	71001900	270899	51,73	5,80	6,00	78	118	71005800	270920	92,82	11,80	12,00	156	204	71011800	270939	291,00
2,00	3,00	38	74	71002000	270900	53,57	5,90	6,00	78	118	71005900	270921	92,82	12,00	12,00	156	204	71012000	270940	291,00
2,10	3,00	38	74	71002100	270901	53,57	6,00	6,00	78	118	71006000	270922	153,13	12,50	14,00	182	230	71012500	270941	397,15
2,20	3,00	38	74	71002200	270902	53,57	6,50	8,00	108	146	71006500	270923	153,13	12,80	14,00	182	230	71012800	270942	397,15
2,30	3,00	38	74	71002300	270903	53,57	6,80	8,00	108	146	71006800	270924	153,13	13,00	14,00	182	230	71013000	270943	397,15
2,40	3,00	38	74	71002400	270904	53,57	7,00	8,00	108	146	71007000	270925	153,13	13,50	14,00	182	230	71013500	270944	397,15
2,50	3,00	44	81	71002500	270905	57,42	7,50	8,00	108	146	71007500	270926	153,13	14,00	14,00	182	230	71014000	270945	397,15
2,60	3,00	44	81	71002600	270906	57,42	7,80	8,00	108	146	71007800	270927	153,13	14,50	16,00	208	260	71014500	270946	523,49
2,70	3,00	44	81	71002700	270907	57,42	8,00	8,00	108	146	71008000	270928	210,98	15,00	16,00	208	260	71015000	270947	523,49
2,80	3,00	44	81	71002800	270908	57,42	8,50	10,00	120	162	71008500	270929	210,98	15,50	16,00	208	260	71015500	270948	523,49
2,90	3,00	54	81	71002900	270909	57,42	8,80	10,00	120	162	71008800	270910	88,68	16,00	16,00	208	260	71016000	270949	523,49

FORETS CARBURE | SERIE LONGUE CARBURE 908 15D / 909 20D



Articles 908 ...

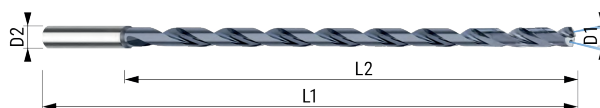

FORETS CARBURE REVÊTU



D1	D2H6	L1	L2	Code	Prix promo		D1	D2H6	L1	L2	Code	Prix promo		D1	D2H6	L1	L2	Code	Prix promo	
					€	net HT						€	net HT						€	net HT
1,00	3	75	18,20	272275	133,57		3,60	6	108	65,50	272301	168,40	6,20	8	148	108,00	272327	223,56		
1,10	3	75	20,20	272276	133,57		3,70	6	108	70,50	272302	168,40	6,30	8	148	108,00	272328	223,56		
1,20	3	75	24,20	272277	133,57		3,80	6	108	70,50	272303	168,40	6,40	8	148	108,00	272329	223,56		
1,30	3	75	24,20	272278	133,57		3,90	6	108	70,70	272304	168,40	6,50	8	160	121,00	272330	223,56		
1,40	3	75	27,20	272279	133,57		4,00	6	120	75,50	272305	186,40	6,60	8	160	121,00	272331	223,56		
1,50	3	75	27,20	272280	133,57		4,10	6	120	75,50	272306	186,40	6,70	8	170	131,00	272332	223,56		
1,60	3	75	30,20	272281	133,57		4,20	6	120	75,50	272307	186,40	6,80	8	170	131,00	272333	223,56		
1,70	3	75	30,20	272282	133,57		4,30	6	120	80,50	272308	186,40	6,90	8	170	131,00	272334	223,56		
1,80	3	75	35,20	272283	133,57		4,40	6	120	80,50	272309	186,40	7,00	8	170	131,00	272335	223,56		
1,90	3	75	35,20	272284	133,57		4,50	6	120	80,50	272310	186,40	7,50	8	170	131,00	272336	223,56		
2,00	4	80	35,50	272285	141,70		4,60	6	125	85,50	272311	186,40	7,80	8	180	141,00	272337	230,67		
2,10	4	80	40,50	272286	141,70		4,70	6	125	85,50	272312	186,40	8,00	8	180	141,00	272338	230,67		
2,20	4	80	40,50	272287	141,70		4,80	6	140	90,50	272313	186,40	8,50	10	198	155,00	272339	300,14		
2,30	4	80	40,50	272288	141,70		4,90	6	140	90,50	272314	186,40	8,80	10	208	165,00	272340	300,14		
2,40	4	90	45,50	272289	141,70		5,00	6	140	90,50	272315	186,40	9,00	10	208	165,00	272341	300,14		
2,50	4	90	45,50	272290	141,70		5,10	6	140	95,50	272316	215,43	9,50	10	208	165,00	272342	300,14		
2,60	4	90	48,50	272291	141,70		5,20	6	140	95,50	272317	215,43	9,80	10	208	165,00	272343	300,14		
2,70	4	90	48,50	272292	141,70		5,30	6	140	95,50	272318	215,43	10,00	10	218	175,00	272344	300,14		
2,80	4	90	50,50	272293	141,70		5,40	6	140	95,50	272319	215,43	10,20	12	235	187,00	272345	430,17		
2,90	4	90	50,50	272294	141,70		5,50	6	150	100,50	272320	215,43	10,50	12	245	197,00	272346	430,17		
3,00	6	100	55,50	272295	168,40		5,60	6	150	100,50	272321	215,43	10,80	12	245	197,00	272347	430,17		
3,10	6	100	55,50	272296	168,40		5,70	6	150	100,50	272322	215,43	11,00	12	245	197,00	272348	430,17		
3,20	6	100	60,50	272297	168,40		5,80	6	150	100,50	272323	215,43	11,20	12	245	197,00	272349	430,17		
3,30	6	100	60,50	272298	168,40		5,90	6	150	100,50	272324	215,43	11,50	12	245	197,00	272350	430,17		
3,40	6	100	60,50	272299	168,40		6,00	6	150	100,50	272325	215,43	11,80	12	255	207,00	272351	430,17		
3,50	6	108	65,50	272300	168,40		6,10	8	148	108,00	272326	223,56	12,00	12	255	207,00	272352	430,17		

Articles 909 ...

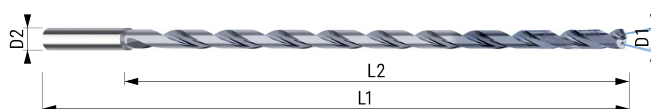

FORETS CARBURE REVÊTU



D1	D2H6	L1	L2	Code	Prix promo		D1	D2H6	L1	L2	Code	Prix promo								
					€	net HT						€	net HT							
2,00	4	95	45,50	272353	141,70		5,00	6	160	115,50	272373	243,08								
2,10	4	95	50,50	272354	141,70		5,50	6	185	140,50	272374	255,27								
2,20	4	95	50,50	272355	141,70		5,80	6	185	140,50	272375	255,27								
2,30	4	95	55,50	272356	141,70		6,00	6	185	140,50	272376	255,27								
2,40	4	95	55,50	272357	141,70		6,50	8	190	150,00	272377	299,28								
2,50	4	108	60,50	272358	141,70		6,80	8	200	160,00	272378	299,28								
2,60	4	108	60,50	272359	141,70		7,00	8	210	170,00	272379	299,28								
2,70	4	108	65,50	272360	141,70		7,50	8	210	170,00	272380	299,28								
2,80	4	108	65,50	272361	141,70		7,80	8	230	190,00	272381	315,83								
2,90	4	112	68,50	272362	141,70		8,00	8	230	190,00	272382	315,83								
3,00	6	112	68,50	272363	210,67		8,50	10	240	196,00	272383	421,66								
3,20	6	120	75,50	272364	210,67		8,80	10	260	216,00	272384	421,66								
3,30	6	120	75,50	272365	210,67		9,00	10	260	216,00	272385	421,66								
3,50	6	130	80,50	272366	210,67		9,80	10	280	236,00	272386	428,95								
3,80	6	140	90,50	272367	210,67		10,00	10	280	236,00	272387	428,95								
4,00	6	140	95,50	272368	210,67		10,20	12	290	241,00	272388	551,65								
4,20	6	140	95,50	272369	210,67		10,80	12	315	266,00	272389	551,65								
4,50	6	160	110,50	272370	226,82		11,80	12	315	266,00	272390	551,65								
4,60	6	160	110,50	272371	226,82		12,00	12	315	266,00	272391	551,65								
4,80	6	160	115,50	272372	243,08															

Articles 910 ...

FORETS CARBURE REVÊTU

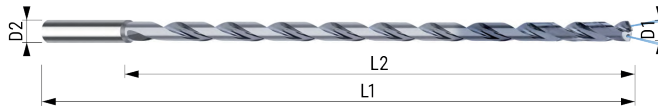

D1	D2H6	L1	L2	Code	Prix promo € net HT	D1	D2H6	L1	L2	Code	Prix promo € net HT
3,00	6	130	85,50	272392	261,32	7,00	8	240	201,00	272407	337,11
3,20	6	140	95,50	272393	261,32	7,50	8	250	214,00	272408	337,11
3,30	6	140	95,50	272394	261,32	7,80	8	260	224,00	272409	356,03
3,50	6	150	100,50	272395	261,32	8,00	8	260	224,00	272410	356,03
3,80	6	150	105,50	272396	269,45	8,50	10	280	237,00	272411	459,34
4,00	6	160	110,50	272397	269,45	8,80	10	290	247,00	272412	461,75
4,20	6	170	120,50	272398	269,45	9,00	10	290	247,00	272413	461,75
4,50	6	180	130,50	272399	279,54	9,50	10	310	267,00	272414	479,98
4,80	6	190	140,50	272400	289,64	9,80	10	310	267,00	272415	479,98
5,00	6	190	140,50	272401	289,64	10,00	10	310	267,00	272416	479,98
5,50	6	210	160,50	272402	295,80	10,20	12	340	295,00	272417	735,54
5,80	6	210	160,50	272403	295,80	10,80	12	350	302,00	272418	735,54
6,00	6	220	170,50	272404	295,80	11,80	12	375	327,00	272419	735,54
6,50	8	230	191,00	272405	337,11	12,00	12	375	327,00	272420	735,54
6,80	8	230	191,00	272406	337,11						

Articles 911 ...

FORETS CARBURE REVÊTU

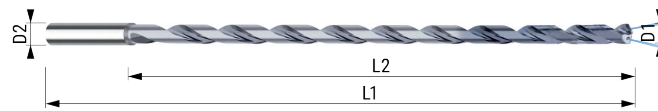

D1	D2H6	L1	L2	Code	Prix promo € net HT	D1	D2H6	L1	L2	Code	Prix promo € net HT
2,00	4	105	65,50	272421	159,69	5,00	6	210	165,50	272439	332,16
2,20	4	115	75,50	272422	159,69	5,50	6	240	180,50	272440	342,61
2,30	4	115	75,50	272423	159,69	5,80	6	240	190,50	272441	342,61
2,40	4	130	85,50	272424	159,69	6,00	6	240	190,50	272442	342,61
2,50	4	130	85,50	272425	159,69	6,50	8	260	222,00	272443	382,07
2,70	4	140	95,50	272426	159,69	6,80	8	260	222,00	272444	382,07
2,80	4	140	95,50	272427	159,69	7,00	8	270	232,00	272445	408,10
2,90	4	140	95,50	272428	159,69	7,50	8	290	252,00	272446	408,10
3,00	6	150	105,50	272429	297,32	7,80	8	300	262,00	272447	412,84
3,10	6	150	105,50	272430	297,32	8,00	8	305	267,00	272448	412,84
3,30	6	160	115,50	272431	311,26	8,50	10	320	278,00	272449	586,91
3,50	6	160	115,50	272432	311,26	8,80	10	340	298,00	272450	586,91
3,80	6	175	125,50	272433	311,26	9,00	10	340	298,00	272451	586,91
4,00	6	185	135,50	272434	318,20	9,50	10	360	318,00	272452	586,91
4,20	6	185	135,50	272435	318,20	9,80	10	380	338,00	272453	586,91
4,50	6	195	145,50	272436	318,20	10,00	10	380	338,00	272454	586,91
4,60	6	205	155,50	272437	318,20						
4,80	6	210	165,50	272438	332,16						

Articles 818 ...

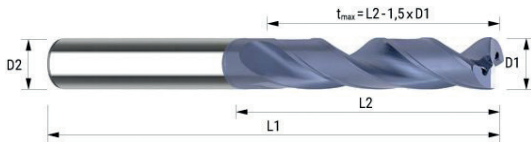

D1	D2	L2	L1	EF	Z	Articles	Code	Prix promo € net HT	D1	D2	L2	L1	EF	Z	Articles	Code	Prix promo € net HT	D1	D2	L2	L1	EF	Z	Articles	Code	Prix promo € net HT		
3,00	6,00	28	66	0,15	2	81803000	272617	75,98	6,60	8,00	53	91	0,33	2	81806600	272654	95,62	10,70	12,00	69	116	0,54	2	81810700	272691	160,17		
3,10	6,00	28	66	0,16	2	81803100	272618	75,98	6,70	8,00	53	91	0,34	2	81806700	272655	95,62	10,80	12,00	69	116	0,54	2	81810800	272692	160,17		
3,20	6,00	28	66	0,16	2	81803200	272619	75,98	6,90	8,00	53	91	0,35	2	81806900	272656	95,62	10,90	12,00	69	116	0,55	2	81810900	272693	160,17		
3,30	6,00	28	66	0,17	2	81803300	272620	75,98	7,00	8,00	53	91	0,35	2	81807000	272657	95,62	11,10	12,00	69	116	0,56	2	81811100	272694	160,17		
3,40	6,00	28	66	0,17	2	81803400	272621	75,98	7,10	8,00	53	91	0,36	2	81807100	272658	95,62	11,20	12,00	69	116	0,56	2	81811200	272695	160,17		
3,50	6,00	28	66	0,18	2	81803500	272622	75,98	7,20	8,00	53	91	0,36	2	81807200	272659	95,62	11,30	12,00	69	116	0,57	2	81811300	272696	160,17		
3,60	6,00	28	66	0,18	2	81803600	272623	75,98	7,30	8,00	53	91	0,37	2	81807300	272660	95,62	11,40	12,00	69	116	0,57	2	81811400	272697	160,17		
3,70	6,00	28	66	0,19	2	81803700	272624	75,98	7,40	8,00	53	91	0,37	2	81807400	272661	95,62	11,50	12,00	69	116	0,58	2	81811500	272698	160,17		
3,80	6,00	36	74	0,19	2	81803800	272625	75,98	7,50	8,00	53	91	0,38	2	81807500	272662	95,62	11,60	12,00	69	116	0,58	2	81811600	272699	160,17		
3,90	6,00	36	74	0,2	2	81803900	272626	75,98	7,60	8,00	53	91	0,38	2	81807600	272663	95,62	11,70	12,00	69	116	0,59	2	81811700	272700	160,17		
4,10	6,00	36	74	0,21	2	81804100	272627	75,98	7,70	8,00	53	91	0,39	2	81807700	272664	95,62	11,80	12,00	69	116	0,59	2	81811800	272701	160,17		
4,20	6,00	36	74	0,21	2	81804200	272628	75,98	7,80	8,00	53	91	0,39	2	81807800	272665	95,62	11,90	12,00	69	116	0,6	2	81811900	272702	160,17		
4,30	6,00	36	74	0,22	2	81804300	272629	75,98	7,90	8,00	53	91	0,4	2	81807900	272666	95,62	12,00	12,00	69	116	0,6	2	81812000	272703	160,17		
4,40	6,00	36	74	0,22	2	81804400	272630	75,98	8,10	10,00	61	103	0,41	2	81808100	272667	114,12	12,50	14,00	75	122	0,63	2	81812500	272704	247,58		
4,50	6,00	36	74	0,23	2	81804500	272631	75,98	8,20	10,00	61	103	0,41	2	81808200	272668	114,12	12,80	14,00	75	122	0,64	2	81812800	272705	247,58		
4,60	6,00	36	74	0,23	2	81804600	272632	75,98	8,30	10,00	61	103	0,42	2	81808300	272669	114,12	13,00	14,00	75	122	0,65	2	81813000	272706	247,58		
4,65	6,00	36	74	0,23	2	818046500	272633	75,98	8,40	10,00	61	103	0,42	2	81808400	272670	114,12	13,50	14,00	75	122	0,68	2	81813500	272707	247,58		
4,70	6,00	36	74	0,24	2	81804700	272634	75,98	8,50	10,00	61	103	0,43	2	81808500	272671	114,12	13,80	14,00	75	122	0,69	2	81813800	272708	247,58		
4,80	6,00	44	82	0,24	2	81804800	272635	79,66	8,60	10,00	61	103	0,43	2	81808600	272672	114,12	14,00	14,00	75	122	0,7	2	81814000	272709	247,58		
4,90	6,00	44	82	0,25	2	81804900	272636	79,66	8,70	10,00	61	103	0,44	2	81808700	272673	114,12	14,50	16,00	81	131	0,73	2	81814500	272710	277,71		
5,00	6,00	44	82	0,25	2	81805000	272637	79,66	8,80	10,00	61	103	0,44	2	81808800	272674	114,12	14,80	16,00	81	131	0,74	2	81814800	272711	277,71		
5,10	6,00	44	82	0,26	2	81805100	272638	79,66	8,90	10,00	61	103	0,45	2	81808900	272675	114,12	15,50	16,00	81	131	0,78	2	81815500	272712	277,71		
5,20	6,00	44	82	0,26	2	81805200	272639	79,66	9,10	10,00	61	103	0,46	2	81809100	272676	114,12	15,80	16,00	81	131	0,79	2	81815800	272713	277,71		
5,30	6,00	44	82	0,27	2	81805300	272640	79,66	9,20	10,00	61	103	0,46	2	81809200	272677	114,12	16,00	16,00	81	131	0,8	2	81816000	272714	277,71		
5,40	6,00	44	82	0,27	2	81805400	272641	79,66	9,30	10,00	61	103	0,47	2	81809300	272678	114,12	16,50	18,00	91	141	0,83	2	81816500	272715	363,56		
5,50	6,00	44	82	0,28	2	81805500	272642	79,66	9,40	10,00	61	103	0,47	2	81809400	272679	114,12	16,80	18,00	91	141	0,84	2	81816800	272716	363,56		
5,55	6,00	44	82	0,28	2	818055500	272643	79,66	9,50	10,00	61	103	0,48	2	81809500	272680	114,12	17,00	18,00	91	141	0,85	2	81817000	272717	363,56		
5,60	6,00	44	82	0,28	2	81805600	272644	79,66	9,60	10,00	61	103	0,48	2	81809600	272681	114,12	17,50	18,00	91	141	0,88	2	81817500	272718	363,56		
5,70	6,00	44	82	0,29	2	81805700	272645	79,66	9,70	10,00	61	103	0,49	2	81809700	272682	114,12	17,80	18,00	91	141	0,89	2	81817800	272719	363,56		
5,80	6,00	44	82	0,29	2	81805800	272646	79,66	9,80	10,00	61	103	0,49	2	81809800	272683	114,12	18,50	20,00	99	151	0,93	2	81818500	272720	464,56		
5,90	6,00	44	82	0,3	2	81805900	272647	79,66	9,90	10,00	61	103	0,5	2	81809900	272684	114,12	18,80	20,00	99	151	0,94	2	81818800	272721	464,56		
6,00	6,00	44	82	0,3	2	81806000	272648	79,66	10,10	12,00	69	116	0,51	2	81811000	272685	160,17	19,00	20,00	99	151	0,95	2	81819000	272722	464,56		
6,10	8,00	53	91	0,31	2	81806100	272649	95,62	10,20	12,00	69	116	0,51	2	81812000	272686	160,17	19,50	20,00	99	151	0,98	2	81819500	272723	464,56		
6,20	8,00	53	91	0,31	2	81806200	272650	95,62	10,30	12,00	69	116	0,52	2	81813000	272687	160,17	19,80	20,00	99	151	0,99	2	81819800	272724	464,56		
6,30	8,00	53	91	0,32	2	81806300	272651	95,62	10,40	12,00	69	116	0,52	2	81810400	272688	160,17	20,00	20,00	99	151	1	2	81820010	272725	466,66		
6,40	8,00	53	91	0,32	2	81806400	272652	95,62	10,50	12,00	69	116	0,53	2	81810500	272689	160,17											
6,50	8,00	53	91	0,33	2	81806500	272653	95,62	10,60	12,00	69	116	0,53	2	81810600	272690	160,17											

Le saviez-vous ?

Inovatools a une application, disponible sur Android et Apple ou ordinateur, pour trouver vos valeurs de coupe

Toutes les valeurs de coupe sont des valeurs conseillées qui ont été déterminées sous des conditions optimales (équipement machine, refroidissement, serrage stable de la pièce à usiner). Inovatools, Eckerle&Eitel GmbH ne peut pas se porter garant pour des valeurs de coupe calculés. Les valeurs de base ont été déterminées par des essais, mais tous les enlèvements de matière individuelles sont calculés et adaptés aux limites enregistrées de la machine.

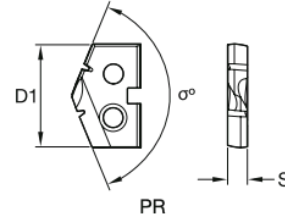
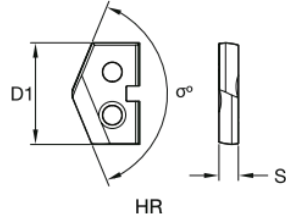
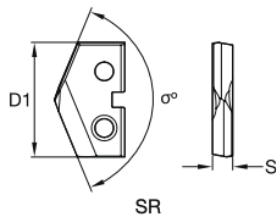
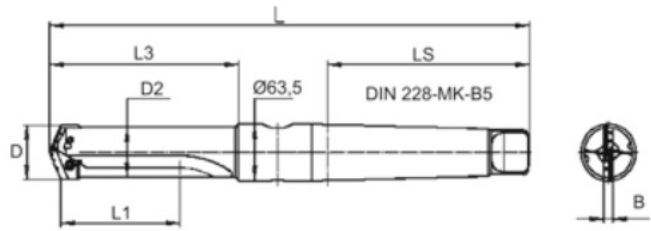

SR



HR



PR

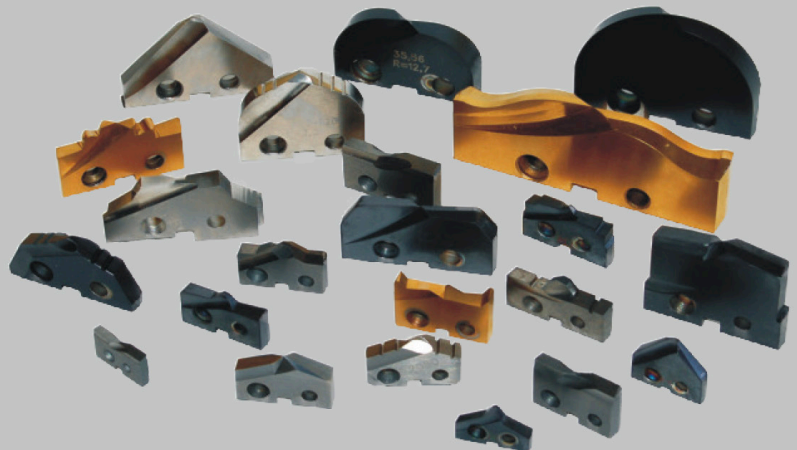

HSSCO5 DIN 338

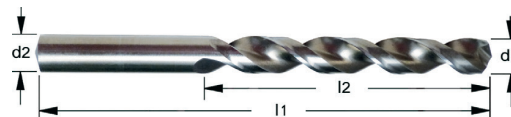

D1	L1	L2	Code	Cdntmt.	Prix promo unit. € HT	D1	L1	L2	Code	Cdntmt.	Prix promo unit. € HT	D1	L1	L2	Code	Cdntmt.	Prix promo unit. € HT
1,00	34	12	022700S	10	1,40	5,75	93	57	022923	10	2,75	10,60	133	87	022889	5	12,62
1,10	36	14	022702	10	1,74	5,80	93	57	022796S	10	2,91	10,70	142	94	022890S	5	12,62
1,20	38	16	022704	10	1,72	5,90	93	57	022798S	10	2,91	10,80	142	94	022891S	5	12,62
1,25	38	16	022914	10	1,67	6,00	93	57	022800S	10	2,63	10,90	142	94	022892	5	12,62
1,30	38	16	022706	10	1,72	6,10	101	63	022802S	10	3,23	11,00	142	94	022893S	5	10,10
1,40	40	18	022708	10	1,72	6,20	101	63	022804S	10	3,23	11,10	142	94	022894S	5	14,36
1,50	40	18	022710S	10	1,36	6,25	101	63	022924	10	3,05	11,20	142	94	022895S	5	14,36
1,60	43	20	022712S	10	1,72	6,30	101	63	022806S	10	3,23	11,30	142	94	022896S	5	14,36
1,70	43	20	022714S	10	1,72	6,40	101	63	022808S	10	3,23	11,40	142	94	022897S	5	14,36
1,75	46	22	022915	10	1,67	6,50	101	63	022810S	10	3,12	11,50	142	94	022898S	5	12,08
1,80	46	22	022716S	10	1,72	6,60	101	63	022812S	10	3,88	11,60	142	94	022899	5	14,84
1,90	46	22	022718S	10	1,72	6,70	101	63	022814S	10	3,88	11,70	142	94	022900S	5	14,84
2,00	49	24	022720S	10	1,39	6,75	109	69	022816	5	3,65	11,80	142	94	022901S	5	14,84
2,10	49	24	022722S	10	1,65	6,80	109	69	022818S	10	3,65	11,90	151	101	022902	5	14,84
2,20	53	27	022724S	10	1,65	6,90	109	69	022820S	10	3,88	12,00	151	101	022903S	5	12,91
2,25	53	27	022916	10	1,58	7,00	109	69	022822S	10	3,41	12,10	151	101	022904S	5	17,22
2,30	53	27	022726S	10	1,65	7,10	109	69	022824S	10	4,94	12,20	151	101	022905S	5	17,22
2,40	57	30	022728S	10	1,65	7,20	109	69	022826S	10	4,94	12,30	151	101	022906S	5	17,22
2,50	57	30	022730S	10	1,28	7,25	109	69	022925	5	4,64	12,40	151	101	022907S	5	17,22
2,60	57	30	022732S	10	1,60	7,30	109	69	022828S	10	4,94	12,50	151	101	022908S	5	15,73
2,70	61	33	022734S	10	1,60	7,40	109	69	022830S	10	4,94	12,60	151	101	022909S	5	17,97
2,75	61	33	022917	10	1,58	7,50	117	75	022832S	10	3,78	12,70	151	101	022910S	5	17,97
2,80	61	33	022736S	10	1,60	7,60	117	75	022834S	10	5,97	12,80	151	101	022911S	5	17,97
2,90	61	33	022738S	10	1,60	7,70	117	75	022836S	10	5,97	12,90	151	101	022912S	5	17,97
3,00	61	33	022740S	10	1,26	7,75	117	75	022926	5	5,63	13,00	151	101	022913S	5	16,10
3,10	65	36	022742	10	1,53	7,80	117	75	022838S	10	5,97	13,50	160	108	020339S	5	17,73
3,20	65	36	022744S	10	1,53	7,90	117	75	022840S	10	5,97	14,00	160	108	022931	5	17,55
3,25	65	36	022918	10	1,53	8,00	117	75	022842S	10	4,38	14,50	169	114	020341S	5	24,87
3,30	65	36	022746S	10	1,53	8,10	117	75	022844S	10	5,68	15,00	169	114	020342S	5	25,26
3,40	70	39	022748S	10	1,60	8,20	117	75	022846S	10	5,68	15,50	178	120	020343S	5	29,24
3,50	70	39	022750S	10	1,52	8,25	117	75	022927	5	5,37	16,00	178	120	020344S	5	30,30
3,60	70	39	022752S	10	1,92	8,30	117	75	022848S	10	5,68	16,50	184	125	020345S	1	34,61
3,70	70	39	022754S	10	1,92	8,40	117	75	022850S	10	5,68	17,00	184	125	020346S	1	34,61
3,75	70	39	022919	10	1,78	8,50	117	75	022852S	10	4,59	17,50	191	130	020347S	1	38,37
3,80	75	43	022756S	10	1,92	8,60	125	81	022854S	10	7,24	18,00	191	130	020348S	1	41,78
3,90	75	43	022758S	10	1,92	8,70	125	81	022856S	10	7,24	18,50	198	135	020349S	1	46,16
4,00	75	43	022760S	10	1,61	8,75	125	81	022928	5	6,84	19,00	198	135	020350S	1	46,16
4,10	75	43	022762S	10	1,78	8,80	125	81	022858S	10	7,24	19,50	205	140	020351S	1	51,17
4,20	75	43	022764S	10	1,78	8,90	125	81	022860S	10	7,24	20,00	205	140	020352S	1	54,82
4,25	75	43	022920	10	1,78	9,00	125	81	022862S	10	5,66						
4,30	80	47	022766S	10	1,92	9,10	125	81	022864S	10	8,03						
4,40	80	47	022768S	10	1,92	9,20	125	81	022866S	10	8,03						
4,50	80	47	022770S	10	1,86	9,25	125	81	022929	5	7,56						
4,60	80	47	022772S	10	2,12	9,30	125	81	022868S	10	8,03						
4,70	80	47	022774S	10	2,12	9,40	125	81	022870S	10	8,03						
4,75	80	47	022921	10	2,00	9,50	125	81	022872S	10	5,87						
4,80	86	52	022776S	10	2,12	9,60	125	81	022874S	10	9,44						
4,90	86	52	022778S	10	2,12	9,70	133	87	022876S	10	9,44						
5,00	86	52	022780S	10	1,94	9,75	133	87	022930	5	8,91						
5,10	86	52	022782S	10	2,31	9,80	133	87	022878S	10	9,44						
5,20	86	52	022784S	10	2,31	9,90	133	87	022880S	10	9,44						
5,25	86	52	022922	10	2,29	10,00	133	87	022882S	5	6,46						
5,30	86	52	022786S	10	2,31	10,10	133	87	022883S	5	10,84						
5,40	93	57	022788S	10	2,31	10,20	133	87	022884S	5	9,15						
5,50	93	57	022790S	10	2,44	10,30	133	87	022886S	5	10,84						
5,60	93	57	022792S	10	2,91	10,40	133	87	022887S	5	10,84						
5,70	93	57	022794S	10	2,91	10,50	133	87	022888S	5	9,15						

Déconditionnement
Majoration 15 %

FORETS FRITTÉ REVETU - CYLINDRIQUES COURTS

NACHI

Autre Ø sur demande
0,01 sur demande jusqu'au Ø8



3D
7572P



D1 mm	D2 mm	L2 mm	L1 mm	Code 7572P	Prix tarif € HT
1,30	3	8	40	028719	10,00
2,00	3	12	44	028720	9,00
2,50	3	14	46	028725	10,71
3,00	3	16	48	028730	10,71
3,30	4	18	50	028733	12,86
3,50	4	20	52	028735	12,86
4,00	4	22	54	028740	13,93
4,20	6	22	66	028742	15,93
4,50	6	24	68	028745	15,93
4,55	6	24	68	028746	22,71
4,65	6	24	68	028744	22,71
5,00	6	26	70	028750	17,71

D1 mm	D2 mm	L2 mm	L1 mm	Code 7572P	Prix tarif € HT
5,10	6	26	70	028751	21,21
5,50	6	28	72	028755	21,21
5,55	6	28	72	028756	29,07
5,90	6	28	72	028757	22,79
6,00	6	28	72	028760	22,79
6,50	8	31	75	028765	23,79
6,80	8	34	78	028766	24,86
6,90	8	34	79	028769	24,86
7,00	8	34	78	028770	24,86
7,50	8	34	78	028775	26,00
8,00	8	37	81	028777	27,36
8,30	8	37	81	028778	29,71

D1 mm	D2 mm	L2 mm	L1 mm	Code 7572P	Prix tarif € HT
8,50	10	37	87	028785	29,71
8,90	10	37	87	028786	31,79
9,00	10	40	90	028787	31,79
9,50	10	40	90	028795	33,86
10,00	10	43	93	028800	35,64
10,20	12	43	100	028802	38,57
10,50	12	43	100	028805	38,57
11,00	12	47	104	028806	42,43
11,50	12	47	104	028815	47,71
12,00	12	51	108	028820	51,50

Exemple

Perçage tôle INOX 304L
Foret 7572P Ø8
Vc 16 m/mn
N 640 tr/mn
F = 64 mm/mn soit 0,1 tour/mn
Profondeur 2 mm
338 trous, pas d'usure

Les forets carbures monobloc
cassaient par manque de rigidité



FORETS HSS CO8% REVETU - CYLINDRIQUES COURTS

NACHI

Autre Ø sur demande
0,01 sur demande jusqu'au Ø8



5D
6568P



D1 mm	L1 mm	L2 mm	Code 6568P	Prix tarif € HT
2,00	44	16	028520	7,36
2,50	50	20	028525	7,57
3,00	54	22	028530	7,57
3,30	57	24	028533	11,14
3,50	61	26	028535	11,14
4,00	65	29	028540	11,79
4,10	65	29	028541	12,36
4,20	65	29	028542	12,36
4,30	65	29	028543	14,29
4,50	69	32	028545	12,36
5,00	74	35	028550	14,57
5,10	74	35	028551	16,43
5,50	80	38	028555	16,43
6,00	80	38	028560	16,86
6,20	86	42	028562	26,29
6,50	86	42	028565	23,07

D1 mm	L1 mm	L2 mm	Code 6568P	Prix tarif € HT
6,80	92	46	028568	27,36
6,90	92	46	028569	27,36
7,00	92	46	028570	23,86
7,50	92	46	028575	25,00
8,00	98	50	028580	26,00
8,50	98	50	028585	30,93
9,00	105	54	028590	30,14
9,50	105	54	028595	36,00
10,00	111	58	028600	36,00
10,20	111	58	028602	39,29
10,50	111	58	028605	39,29
11,00	119	63	028610	59,43
11,50	119	63	028615	61,79
12,00	127	68	028620	64,00

FORETS | FORETS À POINTER CN HSS



HSS h6 N



D1	L1	LONGUEUR UTILE	71175		71176	
			Code	Prix € net HT	Code	Prix € net HT
3,00	46	5,00	028907	9,46	028918	9,46
4,00	55	3,00	028908	9,29	028919	9,29
5,00	62	11,20	028909	9,63	028920	10,11
6,00	66	12,80	028910	9,98	028921	9,98
8,00	79	16,80	028911	16,55	028922	16,55
10,00	89	20,00	028912	18,65	028923	18,65
12,00	102	24,00	028913	23,88	028924	27,14
16,00	115	30,00	028914	30,75	028925	34,91
20,00	131	36,00	028915	56,55	028926	56,55
25,00	151	42,40	028916	104,15		
25,40	156	42,40	028917	107,77	028927	114,38

| DANS LA LIMITE DES STOCKS |

FORETS À PLAQUETTES | KING DRILL - KED DRILL



KING DRILL		KED DRILL		EXEMPLE PRIX KED DRILL	
CAPACITÉ	EXISTE DU Ø 12 AU Ø 60,5 INCREMENTATION 0,5	CAPACITÉ	EXISTE DU Ø 12 AU Ø 60 INCREMENTATION 0,5	E2D 32032 11	281,60
RATIO	2D 3D 4D 5D	RATIO	2D 3D 4D 5D	E3D 32032 11	281,60
				E4D 32032 11	309,77
				E5D 32032 11	449,18

10 PLAQUETTES INTER ET 10 EXTER ACHETÉES = 1 FORET A REMISE 50%

| TARIF ACTUEL EN VIGUEUR |

PLAQUETTE ALU

SPET-ND XOET-ND



PLAQUETTE INOX ET RÉFRACTAIRE

SPMT-LD XOMT-LD



PLAQUETTE UNIVERSELLE

SPMT-PD XOMT-PD XOMT-RD





HSS 5% COBALT
< 2,5 D



HSS 5% COBALT
< 2,5 D



FRITTÉ
< 3 D



FRITTÉ
< 3 D

TOLÉRANCE ENTRÉE GOUJURE			A15S TIN 6H B = 4 5 FILETS DROITE		A70S TIN 6H C = 2 3 FILETS HÉLICOÏDALE 40°		P15 TIH1 6HX B = 4 5 FILETS DROITE		P70 TIH1 6HX C = 2 3 FILETS HÉLICOÏDALE 45°	
Ø	Pas		Code	Prix promo € HT	Code	Prix promo € HT	Code	Prix promo € HT	Code	Prix promo € HT
M2	x 0,40						042650	21,78	042670	23,78
M2,5	x 0,45						042651	21,78	042671	23,78
M3	x 0,50		041452	15,43	047504	16,55	042652	18,97	042672	20,86
M4	x 0,70		041453	15,43	047505	16,55	042653	18,97	042673	20,86
M5	x 0,80		041454	15,43	047506	16,55	042654	19,50	042674	20,96
M6	x 1,00		041455	15,43	047507	16,55	042655	20,61	042675	21,89
M8	x 1,25		041456	19,14	047508	20,43	042656	23,84	042676	26,30
M10	x 1,50		041457	22,72	047509	24,35	042657	30,71	042677	33,84
M12	x 1,75		041458	27,97	047510	30,26	042658	45,43	042678	50,59
M14	x 2,00		041459	41,93	047511	41,69	042659	58,68	042679	66,59
M16	x 2,00		041460	42,46	047512	41,69	042660	63,27	042680	72,84
M18	x 2,50						042661	110,91	042681	115,68
M20	x 2,50		041462	73,45	047515	77,80	042662	144,89	042682	149,29



HSS 5% COBALT



HSS 5% COBALT



HSS 5% COBALT

Ø	Pas		A20S TiCN		A34 TIN		A61 TiCN	
			Code	Prix promo € HT	Code	Prix promo € HT	Code	Prix promo € HT
2	64	UNF	040919	32,77	040831	28,97	047001	33,31
3	56	UNF	040920	31,50	040832	27,82	047002	31,74
4	48	UNF	040921	30,66	040833	26,85	047003	30,78
5	44	UNF	040922	30,66	040834	26,85	047004	30,78
6	40	UNF	040923	29,45	040835	26,31	047005	29,81
8	36	UNF	040924	29,45	040836	26,31	047006	29,81
10	32	UNF	040925	30,66	040837	27,03	047007	30,78
12	28	UNF	040926	33,13	040838	29,27	047008	33,43
1/4		UNF	040927	33,13	040839	29,27	047009	33,43
5/16		UNF	040928	37,53	040840	33,37	047010	38,02
3/8		UNF	040929	40,49	040841	36,45	047011	40,91
7/16		UNF	040930	51,41	040842	45,98	047012	51,96
1/2		UNF	040931	53,10	040843	47,55	047013	53,95
9/16		UNF	040932	77,00	040844	68,31	047014	77,78
5/8		UNF	040933	75,91	040845	68,07	047015	77,00
3/4		UNF	040934	118,70	040846	108,02	047016	120,03
7/8		UNF	040935	142,84	040847	129,38	047017	144,22
1"	12	UNF	040936	220,32	040848	200,53	047018	222,19

TARAUDS MACHINE VERGNANO | HSS 5% COLBALT - UNC



A19S TiCN



A60S TiCN



A33 TiN

Ø	Pas	Code	Prix promo € HT	Code	Prix promo € HT	Code	Prix promo € HT	
2	56	UNC	040867	31,50	040849	31,74	040885	27,82
3	48	UNC	040868	30,23	040850	30,78	040886	26,85
4	40	UNC	040869	28,60	040851	28,78	040887	25,34
5	40	UNC	040870	28,60	040852	28,78	040888	25,34
6	32	UNC	040871	27,58	040853	27,88	040889	24,62
8	32	UNC	040872	27,58	040854	27,88	040890	24,62
10	24	UNC	040873	29,81	040855	29,99	040891	26,37
12	24	UNC	040874	30,11	040856	30,66	040892	26,73
1/4	20	UNC	040875	31,14	040857	33,13	040893	27,58
5/16	18	UNC	040876	35,30	040858	35,72	040894	31,68
3/8	16	UNC	040877	38,50	040859	39,10	040895	34,88
7/16	14	UNC	040878	48,16	040860	48,82	040896	43,15
1/2	13	UNC	040879	49,72	040861	50,39	040897	44,59
9/16	12	UNC	040880	72,29	040862	72,72	040898	64,51
5/8	11	UNC	040881	72,05	040863	72,66	040899	64,51
3/4	10	UNC	040882	111,88	040864	112,91	040900	102,22
7/8	9	UNC	040883	136,14	040865	137,41	040901	123,89
1"	8	UNC	040884	207,22	040866	207,22	040902	188,28

TARAUDS MACHINE VERGNANO | HSS FRITTÉ - G



P18 TiH1



P59 TiH1

Ø	Pas	Code	Prix promo € HT	Code	Prix promo € HT
1/8	28F	040807	47,37	040800	47,85
1/4	19F	040808	69,22	040801	69,76
3/8	19F	040809	84,78	040802	85,57
1/2	14F	040810	143,20	040803	145,19
5/8	14F	040811	170,84	040804	172,65
3/4	14F	040812	246,03	040805	248,08
1"11	11F	040813	357,00	040806	359,96

TARAUDS MACHINE VERGNANO | P150 - P170



INOX | ACIER

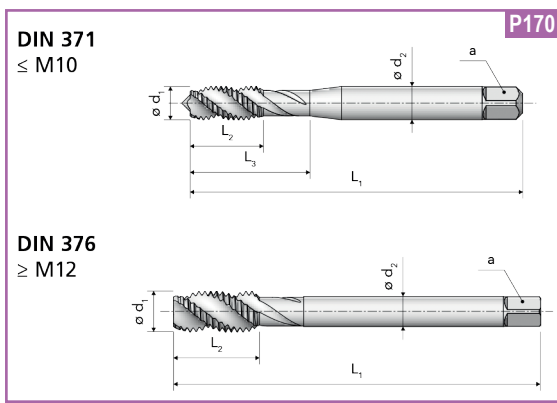
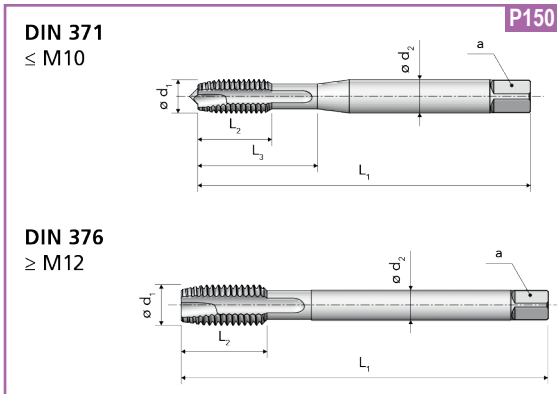

P150



P170



Revetement
G MAXX

6HX

6HX

ød1	P	L1	L2	L3	ød2	a	Z		Code	Prix promo € HT	Code	Prix promo € HT
M3	0,5	56	10	18	3,5	2,7	3	2,5	047867	28,91	047878	31,92
M4	0,7	63	12	21	4,5	3,4	3	3,3	047868	28,91	047879	31,92
M5	0,8	70	14	25	6	4,9	3	4,2	047869	28,91	047880	31,92
M6	1	80	16	29	6	4,9	3	5	047870	28,91	047881	31,92
M8	1,25	90	18	33	8	6,2	3	6,8	047871	35,30	047882	39,65
M10	1,5	100	20	36	10	8	3	8,5	047872	43,81	047883	49,24
M12	1,75	110	24	-	9	7	3	10,2	047873	55,70	047884	62,82
M14	2	110	25	-	11	9	3	12	047874	77,42	047885	83,46
M16	2	110	28	-	12	9	3	14	047875	84,18	047886	95,04
M18	2,5	125	32	-	14	11	4	15,5	047876	116,47	047887	124,91
M20	2,5	140	32	-	16	12	4	17,5	047877	152,07	047888	160,88

TARAUDS À REFOULER VERGNANO | P900 N RED-MAXX



INOX | ACIER



6HX



ød1	P	L1	L2	L3	ød2	a	Z		Code	Prix promo € HT
M2	0,4	45	4	11	2,8	2,1	3	1,85	047853	47,43
M2,5	0,45	50	4,5	14	2,8	2,1	4	2,3	047854	44,66
M3	0,5	56	5	17	3,5	2,7	4	2,8	047855	39,95
M3,5	0,6	56	6	19	4	3	4	3,25	047856	39,95
M4	0,7	63	7	21	4,5	3,4	5	3,7	047857	39,95
M5	0,8	70	8	25	6	4,9	5	4,65	047858	39,95
M6	1	80	10	29	6	4,9	5	5,6	047859	39,95
M7	1	80	10	29	7	5,5	5	6,6	047860	60,71
M8	1,25	90	13	35	8	6,2	5	7,45	047861	50,15
M10	1,5	100	15	39	10	8	6	9,35	047862	63,36
M12	1,75	110	18	-	9	7	8	11,25	047863	75,25
M14	2	110	20	-	11	9	8	13,1	047864	100,96
M16	2	110	20	-	12	9	8	15,1	047865	125,88
M20	2,5	140	25	-	16	12	8	18,9	047866	221,95

DIN 2174 (371)
≤ M10

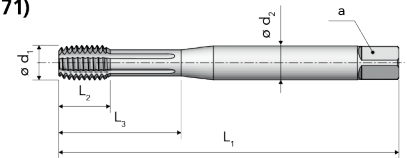

DIN 2174 (376)
≥ M12

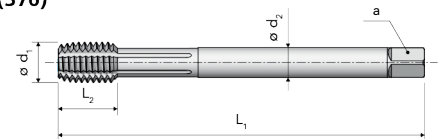

TARAUDS À REFOULER VERGNANO | HSSK FRITTÉ - M



INOX | ACIER



P80 TIN

< 1,5 D



P80N TIN

AVEC GOUJURE DE LUBRIFICATION

< 3 D



P80 V MAXX

< 1,5 D

TOLÉRANCE ENTRÉE		6HX C = 2 3 FILETS		6HX C = 2 3 FILETS		6HX C = 2 3 FILETS	
∅	Pas	Code	Prix promo € HT	Code	Prix promo € HT	Code	Prix promo € HT
M2	x 0,40	042592	36,81	042608	39,50	047841	41,13
M2,5	x 0,45	042593	34,75	042609	37,31	047842	38,81
M3	x 0,50	042594	31,06	042610	33,31	047843	34,75
M3,5	x 0,60	042595	31,06	042611	33,31	047844	34,75
M4	x 0,70	042596	31,06	042612	33,31	047845	34,75
M5	x 0,80	042597	31,06	042613	33,31	047846	34,75
M6	x 1,00	042598	31,06	042614	33,31	047847	34,75
M8	x 1,25	042599	39,13	042615	41,88	047848	43,75
M10	x 1,50	042600	49,63	042616	52,88	047849	55,31
M12	x 1,75	042601	58,69	042617	62,81	047850	65,50
M14	x 2,00	042602	78,88	042618	84,19	047851	88,19
M16	x 2,00	042603	98,19	042619	105,13	047852	109,50
M18	x 2,50			042620	164,44		
M20	x 2,50			042621	217,50		

TARAUDS MACHINE BASS | INOX | ACIER | TITANE



INOX | ACIER | ALUMINIUM



VARIANT 1 VA



DOMINANT 1 VA45



TARAUDS INOX ACIER ALU.	Code	Prix promo € net HT
TAR BASS GUN 14.2311 REV HL M3	043035	26,48
TAR BASS GUN 14.2311 REV HL M4	043036	27,69
TAR BASS GUN 14.2311 REV HL M5	043037	29,77
TAR BASS GUN 14.2311 REV HL M6	043038	30,12
TAR BASS GUN 14.2311 REV HL M8	043039	37,04
TAR BASS GUN 14.2311 REVHL M10	043040	41,88
TAR BASS GUN 14.2411 REVHL M12	043041	56,42
TAR BASS GUN 14.2411 REVHL M16	043042	74,08
TAR BASS GUN 14.2411 REVHL M20	043043	114,23

- HSSE PM
- ENTRÉE : B (3,5 - 5)
- REVÊTEMENT : TIALN
- GOUJURE : DROITE



TARAUDS INOX ACIER ALU.	Code	Prix promo € net HT
TAR BASS TH 16.6141 REV HL M3	043020	29,94
TAR BASS TH 16.6141 REV HL M4	043021	29,94
TAR BASS TH 16.6141 REV HL M5	043022	31,15
TAR BASS TH 16.6141 REV HL M6	043023	32,19
TAR BASS TH 16.6141 REV HL M8	043024	40,15
TAR BASS TH 16.6141 REV HL M10	043025	46,04
TAR BASS TH 16.6241 REV HL M12	043026	61,62
TAR BASS TH 16.6241 REV HL M14	043027	78,92
TAR BASS TH 16.6241 REV HL M16	043028	85,15
TAR BASS TH 16.6241 REV HL M20	043029	126,00

- HSSE PM
- ENTRÉE : C (2 -3)
- REVÊTEMENT : TIALN
- GOUJURE : HÉLICOÏDALE 45°

TARAUDS MACHINE BASS | INOX | ACIER | TITANE

BASS
TECHNIK FÜR GEWINDE

TITANE | INOX



AVANT 1 TIH13



TARAUDS TITANE ACIER		Code	Prix promo € net HT
TAR BASS TH 25.2131	M3 TICN	043050	32,02
TAR BASS TH 25.2131	M4 TICN	043051	32,88
TAR BASS TH 25.2131	M5 TICN	043052	35,65
TAR BASS TH 25.2131	M6 TICN	043053	35,65
TAR BASS TH 25.2131	M8 TICN	043054	43,27
TAR BASS TH 25.2131	M10 TICN	043055	49,85
TAR BASS TH 25.2231	M12 TICN	043056	69,23

- HSSE PM
- ENTRÉE : B (3,5 - 5)
- REVÊTEMENT : TICN
- GOJJURE : DROITE

VARIANT 1 TIH



TARAUDS TITANE ACIER		Code	Prix promo € net HT
TAR BASS GUN 25.2311	M3 TICN	043060	31,50
TAR BASS GUN 25.2311	M4 TICN	043061	32,19
TAR BASS GUN 25.2311	M5 TICN	043062	35,65
TAR BASS GUN 25.2311	M6 TICN	043063	37,04
TAR BASS GUN 25.2311	M8 TICN	043064	43,27
TAR BASS GUN 25.2311	M10 TICN	043065	51,23
TAR BASS GUN 25.2411	M12 TICN	043066	67,50

- HSSE PM
- ENTRÉE : C (2 -3)
- REVÊTEMENT : TICN
- GOJJURE : HÉLICOÏDALE 13°

TARAUDS MACHINE BASS | MJ | UNJ

BASS
TECHNIK FÜR GEWINDE

TITANE | INOX



VARIANT TIH TICN



Type	Exécution	Pas	Diam.	Pas	Code	Prix promo € net HT
VARIANT 1 TIH	TICN	MJ	4	0,70	043069	57,46
VARIANT 1 TIH	TICN	MJ	5	0,80	043070	63,69
VARIANT 1 TIH	TICN	MJ	6	1,00	043071	65,42
VARIANT 1 TIH	TICN	MJ	8	1,25	043087	77,54
VARIANT 1 TIH	TICN	MJ	10	1,50	043088	92,77
VARIANT 1 TIH	TICN	UNJC	No6	32	043089	47,08
VARIANT 1 TIH	TICN	UNJC	No8	32	043072	47,77
VARIANT 1 TIH	TICN	UNJC	No10	24	043073	51,58
VARIANT 1 TIH	TICN	UNJC	1/4"	20	043074	53,65
VARIANT 1 TIH	TICN	UNJC	5/16"	18	043090	63,00
VARIANT 1 TIH	TICN	UNJC	3/8"	16	043091	74,08
VARIANT 1 TIH	TICN	UNJF	No6	40	043092	49,85
VARIANT 1 TIH	TICN	UNJF	No8	36	043075	50,19
VARIANT 1 TIH	TICN	UNJF	No10	32	043076	54,69
VARIANT 1 TIH	TICN	UNJF	1/4"	28	043077	57,12
VARIANT 1 TIH	TICN	UNJF	5/16"	24	043093	67,85
VARIANT 1 TIH	TICN	UNJF	3/8"	24	043094	78,92

TARAUDS MACHINE BASS | SÉRIE LONGUE

BASS
TECHNIK FÜR GEWINDE

TITANE | INOX | ACIER | ALUMINIUM



DOMINANT 1 LT45 TIN SL

VARIANT 1 LT TIN SL

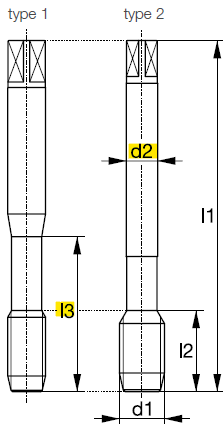

Type	Lt	D2	L3	Référence	Prix tarif € net HT	L3	Référence	Prix tarif € net HT
M 3	100	3,5	18	780168	47,75	20	780065	47,25
M 4	125	4,5	21	780169	47,75	27	780066	46,50
M 4	125	2,8	-	780178	65,00	-	780075	49,50
M 5	160	6,0	25	780170	49,25	33	780067	48,75
M 5	160	3,5	-	780179	79,50	-	780076	53,50
M 6	160	6,0	30	780171	50,50	40	780068	50,00
M 6	160	4,5	-	780180	88,50	-	780077	65,00
M 8	180	8,0	35	780172	60,50	52	780069	60,50
M 8	180	6,0	-	780181	97,00	-	780078	74,00
M 10	200	10,0	39	780173	71,00	65	780070	69,00
M 10	200	7,0	-	780182	115,00	-	780079	82,50
M 12	200	9,0	-	780174	92,00	-	780071	95,50
M 14	200	11,0	-	780175	112,00	-	780072	116,00
M 16	200	12,0	-	780176	130,00	-	780073	126,00
M 20	200	16,0	-	780177	206,00	-	780074	187,00

TARAUDS MACHINE BASS | SÉRIE NORMALE

BASS
TECHNIK FÜR GEWINDE

TITANE | INOX | ACIER | ALUMINIUM



DOMINANT 1 LT45 TIN HSSE

Type	Lt	Code	Prix promo € net HT
DOMINANT 1 LT45 TIN M 3	63	043135	14,45
DOMINANT 1 LT45 TIN M 4	70	043136	12,93
DOMINANT 1 LT45 TIN M 5	80	043137	14,09
DOMINANT 1 LT45 TIN M 6	90	043138	14,09
DOMINANT 1 LT45 TIN M 8	100	043139	16,29
DOMINANT 2 LT45 TIN M 10	100	043140	19,79
DOMINANT 2 LT45 TIN M 12	110	043141	24,71

Autres diamètres disponibles sur demande



VARIANT 1 LT TIN HSSE

Type	Lt	Code	Prix promo € net HT
VARIANT 1 LT TIN M 3	63	043128	14,54
VARIANT 1 LT TIN M 4	70	043129	13,43
VARIANT 1 LT TIN M 5	80	043130	13,43
VARIANT 1 LT TIN M 6	90	043131	13,43
VARIANT 1 LT TIN M 8	100	043132	16,18
VARIANT 2 LT TIN M 10	100	043133	19,86
VARIANT 2 LT TIN M 12	110	043134	24,84

Autres diamètres disponibles sur demande

AVANT TIH13 TICN



Type	Éxecution	Pas	Diam.	Pas	Code	Prix promo € net HT
AVANT 1 TIH13	TICN	MJ	4	0,70	043095	54,69
AVANT 1 TIH13	TICN	MJ	5	0,80	043078	60,58
AVANT 1 TIH13	TICN	MJ	6	1,00	043079	62,65
AVANT 1 TIH13	TICN	MJ	8	1,25	043080	74,77
AVANT 1 TIH13	TICN	MJ	10	1,50	043096	86,54
AVANT 1 TIH13	TICN	UNJC	No6	32	043097	44,65
AVANT 1 TIH13	TICN	UNJC	No8	32	043098	45,00
AVANT 1 TIH13	TICN	UNJC	No10	24	043081	49,15
AVANT 1 TIH13	TICN	UNJC	1/4"	20	043082	50,19
AVANT 1 TIH13	TICN	UNJC	5/16"	18	043083	60,58
AVANT 1 TIH13	TICN	UNJC	3/8"	16	043099	70,62
AVANT 1 TIH13	TICN	UNJF	No6	40	043100	47,77
AVANT 1 TIH13	TICN	UNJF	No8	36	043101	48,46
AVANT 1 TIH13	TICN	UNJF	No10	32	043084	50,19
AVANT 1 TIH13	TICN	UNJF	1/4"	28	043085	54,00
AVANT 1 TIH13	TICN	UNJF	5/16"	24	043086	63,69
AVANT 1 TIH13	TICN	UNJF	3/8"	24	043102	74,77



VARIANT H VAP



TARAUDS INOX ACIER	Code	Prix promo € net HT
TAR BASS LP GUN VAP M3	043010	15,58
TAR BASS LP GUN VAP M4	043011	16,15
TAR BASS LP GUN VAP M5	043012	17,50
TAR BASS LP GUN VAP M6	043013	17,50
TAR BASS LP GUN VAP M8	043014	20,00
TAR BASS LP GUN VAP M10	043015	24,04
TAR BASS LP GUN VAP M12	043016	27,88
TAR BASS LP GUN VAP M14	043019	36,35
TAR BASS LP GUN VAP M16	043017	40,00
TAR BASS LP GUN VAP M20	043018	61,92

- HSSE PM
- ENTRÉE : B (3,5 - 5,4)
- REVÊTEMENT : VAP
- TROU DÉBOUCHANT

DOMINANT HZ38 VAP



TARAUDS INOX ACIER	Code	Prix promo € net HT
TAR BASS LP TH VAP M3	043001	16,35
TAR BASS LP TH VAP M4	043002	17,12
TAR BASS LP TH VAP M5	043003	18,08
TAR BASS LP TH VAP M6	043004	18,08
TAR BASS LP TH VAP M8	043005	20,77
TAR BASS LP TH VAP M10	043006	25,00
TAR BASS LP TH VAP M12	043007	28,65
TAR BASS LP TH VAP M14	043031	34,42
TAR BASS LP TH VAP M16	043008	41,15
TAR BASS LP TH VAP M20	043009	56,54

- HSSE PM
- ENTRÉE : C (2 - 3)
- REVÊTEMENT : VAP
- TROU BORGNE

TARAUDS MACHINE

TARAUDS CARBURE



TARAUD FANAR CARBURE TiCN HRC60					Prix promo € HT	TARAUD VERGNANO CARBURE V MAXX H130					Prix promo € HT
					Code						Code
C9	135F01	0030	M3	045700	57,92	A000301309A1AV0	M3x0,5	042729			184,69
C9	135F01	0040	M4	045701	59,76	A000401309A1AV0	M4x0,7	042730			186,63
C9	135F01	0050	M5	045702	61,53	A000501309A1AV0	M5,08	042731			187,33
C9	135F01	0060	M6	045703	68,77	A000601309A1AV0	M6x1,00	042732			189,27
C9	135F01	0080	M8	045704	83,25	A000801309A1AV0	M8x1,25	042733			234,93
						A001001309A1AV0	M10x1,5	042734			261,85
						A001201309A1AV0	M12x1,75	042735			277,20

- HRC 60
- REVÊTEMENT : TiCN
- GOUJURE : DROITE

- H130
- REVÊTEMENT : V MAXX
- GOUJURE : DROITE

BRAS DE TARAUDAGE ÉLECTRIQUE



À PARTIR DE
1275
€ HT*



Modèle	GS 1100-16 E	GS 1200-24 E	GS 1200-36 E
Puissance moteur	0.6 kW / 230 V ~ 50Hz	1.2 kW / 230 V ~ 50Hz	
Entraînement	Electrique	Electrique	Electrique
Taraudage à 400 N / mm ²	M3 - M16	M6 - M24	M6 - M36
Vitesse	312 T/min	250 T/min	156 T/min
Rayon d'action	1100 mm	1200 mm	
Angle	0 - 90°	0 - 90°	0 - 90°
Dimension (L x l x h)	930 x 90 x 520 mm	1400 x 100 x 700 mm	1400 x 100 x 700 mm
Poids net (brut)	25 kg (32 kg)	45 kg (52 kg)	50 kg (61 kg)
Code	0450005	0450006	0450007
Prix	1 275 € HT*	1 679 € HT*	1 749 € HT*

Le saviez-vous ?

Nous vendons aussi
le socle
Code : 0450008

1 299
€ HT*



| SOUS RÉSERVE DE HAUSSE TARIFAIRE |

KG

53

PORTE-OUTILS AKKO | TOURNAGE EXTÉRIEUR

PORTE - OUTILS A LEVIER TYPE P



Utilisations	Carre
POUR PLAQUETTES TYPE CN.../WN.../TN...	CARRE 20
POUR PLAQUETTES TYPE CN.../WN.../TN...	CARRE 25
POUR PLAQUETTES DN	CARRE 20
POUR PLAQUETTES DN	CARRE 25

Désignation	Référence	Code
PCLNR 2020 K12C	M.01.01.04.01.02	098285
PCLNL 2020 K12C	M.01.01.04.02.02	098286
PDJNR 2020 K15C	M.01.01.04.05.04	098287
PDJNL 2020 K15C	M.01.01.04.06.05	098288
PWLNK 2020 K08C	M.01.01.04.17.02	098289
PWLNK 2020 K06	M.01.01.04.17.07	098290
PWLNK 2020 K08C	M.01.01.04.18.02	098291
PWLNK 2020 K06	M.01.01.04.18.07	098292
PCLNR 2525 M12C	M.01.01.04.01.03	098293
PCLNL 2525 M12C	M.01.01.04.02.03	098294
PDJNR 2525 M15C	M.01.01.04.05.05	098295
PDJNL 2525 M11	M.01.01.04.06.04	098296
PDJNL 2525 M15C	M.01.01.04.06.06	098297
PWLNK 2525 M08C	M.01.01.04.17.03	098298
PWLNK 2525 M06	M.01.01.04.17.06	098299
PWLNK 2525 M08C	M.01.01.04.18.03	098300

**41€
HT**

PORTE-OUTILS | TOURNAGE INTÉRIEUR



Longueurs

H = 100	R = 200
K = 125	S = 250
M = 150	T = 300
P = 170	U = 350



Porte-outils intérieur	Référence	Code	Prix promo € HT
S08H SCLCL 06	M.01.02.03.10.01	098302	18,88
S10K SCLCL 06	M.01.02.03.10.02	098303	21,48
S12K SCLCL 06	M.01.02.03.10.03	098304	22,75
S12K SCLCL 09	M.01.02.03.10.28	098305	22,75
S16P SCLCL 09	M.01.02.03.10.07	098306	25,98
S16P SCLCL 06	M.01.02.03.10.29	098307	25,98
S20R SCLCL 09	M.01.02.03.10.08	098308	27,31
S25S SCLCL 09	M.01.02.03.10.10	098309	36,37
S25S SCLCL 12	M.01.02.03.10.18	098310	36,37
S32T SCLCL 09	M.01.02.03.10.11	098311	55,25
S32T SCLCL 12	M.01.02.03.10.19	098312	55,25
S08H SCLCR 06	M.01.02.03.09.01	098313	18,88
S10K SCLCR 06	M.01.02.03.09.02	098314	21,48
S12K SCLCR 06	M.01.02.03.09.03	098315	22,75
S12K SCLCR 09	M.01.02.03.09.27	098316	22,75
S16P SCLCR 09	M.01.02.03.09.07	098317	25,98
S16P SCLCR 06	M.01.02.03.09.28	098318	25,98
S20R SCLCR 09	M.01.02.03.09.08	098319	27,31
S25S SCLCR 09	M.01.02.03.09.10	098320	36,37
S25S SCLCR 12	M.01.02.03.09.18	098321	36,37
S32T SCLCR 09	M.01.02.03.09.11	098322	55,25
S32T SCLCR 12	M.01.02.03.09.19	098323	55,25

Porte-outils intérieur	Référence	Code	Prix promo € HT
A08H SCLCL 06	M.01.02.03.10.04	098324	22,75
A10H SCLCL 06	M.01.02.03.10.05	098325	25,34
A12H SCLCL 06	M.01.02.03.10.06	098326	27,31
A16M SCLCL 09	M.01.02.03.10.12	098327	32,50
A20P SCLCL 09	M.01.02.03.10.13	098328	33,14
A25R SCLCL 09	M.01.02.03.10.15	098329	46,13
A25R SCLCL 12	M.01.02.03.10.22	098330	46,13
A32S SCLCL 09	M.01.02.03.10.16	098331	70,14
A08H SCLCR 06	M.01.02.03.09.04	098332	22,75
A10H SCLCR 06	M.01.02.03.09.05	098333	25,34
A12H SCLCR 06	M.01.02.03.09.06	098334	27,31
A16M SCLCR 09	M.01.02.03.09.12	098335	32,50
A20P SCLCR 09	M.01.02.03.09.13	098336	33,14
A25R SCLCR 09	M.01.02.03.09.15	098337	46,13
A25R SCLCR 12	M.01.02.03.09.22	098338	46,13
A32S SCLCR 09	M.01.02.03.09.16	098339	70,14

PORTE-OUTILS AKKO | TOURNAGE INTÉRIEUR



KAPR=93°

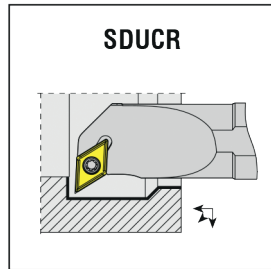

SDUCR

Longueurs	
H = 100	R = 200
K = 125	S = 250
M = 150	T = 300
P = 170	U = 350

Porte-outils intérieur	Référence	Code	Prix promo € HT
A10H SDUCL 07	M.01.02.03.02.05	098340	25,34
A12H SDUCL 07	M.01.02.03.02.06	098341	27,31
A16M SDUCL 07	M.01.02.03.02.07	098342	32,50
A16M SDUCL 11	M.01.02.03.02.15	098343	32,50
A20P SDUCL 07	M.01.02.03.02.08	098344	33,14
A20P SDUCL 11	M.01.02.03.02.16	098345	33,14
A25R SDUCL 11	M.01.02.03.02.17	098346	46,13
A32S SDUCL 11	M.01.02.03.02.18	098347	70,14
A10H SDUCR 07	M.01.02.03.01.05	098348	25,34
A12H SDUCR 07	M.01.02.03.01.06	098349	27,31
A16M SDUCR 11	M.01.02.03.01.12	098350	32,50
A16M SDUCR 07	M.01.02.03.01.16	098351	32,50
A20P SDUCR 11	M.01.02.03.01.13	098352	33,14
A20P SDUCR 07	M.01.02.03.01.27	098353	33,14
A25R SDUCR 11	M.01.02.03.01.14	098354	46,13
A25T SDUCR 11	M.01.02.03.01.54	098355	87,06
A32S SDUCR 11	M.01.02.03.01.15	098356	70,14



KAPR=117.5°

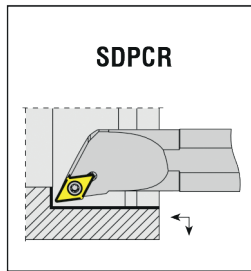

SDPCR

Porte-outils intérieur	Référence	Code	Prix promo € HT
S10K SDPCL 07	M.01.02.03.44.04	098357	21,48
S12K SDPCL 07	M.01.02.03.44.01	098358	22,75
S16P SDPCL 11	M.01.02.03.44.02	098359	25,98
S20R SDPCL 11	M.01.02.03.44.03	098360	27,31
S25S SDPCL 11	M.01.02.03.44.05	098361	36,37
S10K SDPCR 07	M.01.02.03.41.03	098362	21,48
S12K SDPCR 07	M.01.02.03.41.02	098363	22,75
S16P SDPCR 11	M.01.02.03.41.04	098364	25,98
S20R SDPCR 11	M.01.02.03.41.01	098365	27,31
S25S SDPCR 11	M.01.02.03.41.05	098366	36,37



KAPR=95°

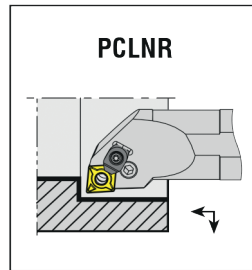

PCLNR

Porte-outils intérieur	Référence	Code	Prix promo € HT
A20P PCLNL 09	M.01.02.04.02.30	098367	53,92
A25R PCLNL 12C	M.01.02.04.02.05	098368	64,95
A32S PCLNL 12C	M.01.02.04.02.06	098369	77,94
A32T PCLNL 12	M.01.02.04.01.30	098370	92,89
A40T PCLNL 12C	M.01.02.04.02.07	098371	102,65
A50U PCLNL 12C	M.01.02.04.02.16	098372	124,70
A20P PCLNR 09	M.01.02.04.01.29	098373	53,92
A25R PCLNR 12C	M.01.02.04.01.05	098374	64,95
A25S PCLNR 12C	M.01.02.04.01.17	098375	72,74
A32S PCLNR 12C	M.01.02.04.01.06	098376	77,94
A40T PCLNR 12C	M.01.02.04.01.07	098377	102,65
A50U PCLNR 12C	M.01.02.04.01.20	098378	124,70

KITS BARRE D'ALÉSAGE

Diamètre 8-10-12-16

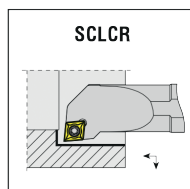

SCLCR



Désignation	Référence	Code	Prix promo € HT
SET-S/SCLCR	M.01.02.03.54.03	098379	109,81
SET-S/SCLCL	M.01.02.03.54.10	098380	109,81
SET-A/SCLCR	M.01.02.03.54.01	098381	127,99
SET-A/SCLCL	M.01.02.03.54.08	098382	127,99
SET-E/SCLCR	M.01.02.03.54.02	098383	1123,02
SET-E/SCLCL	M.01.02.03.54.09	098384	1123,02

PORTE-OUTILS AKKO

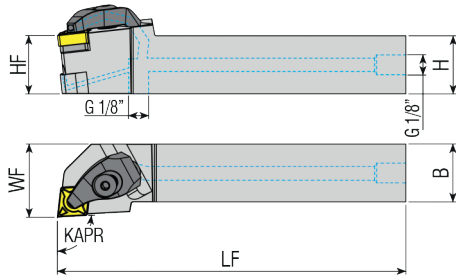

KAPR=95°
TCLN

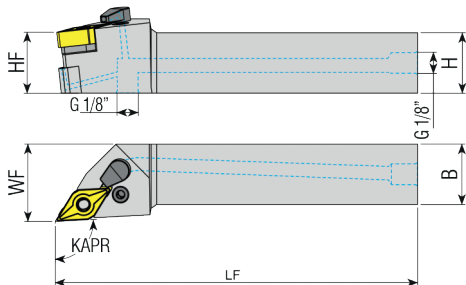
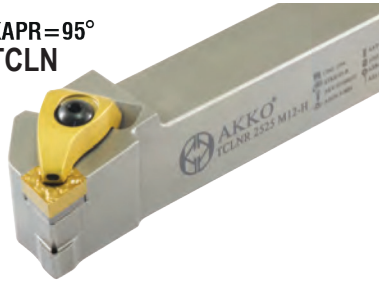

KAPR=93°
PDJN

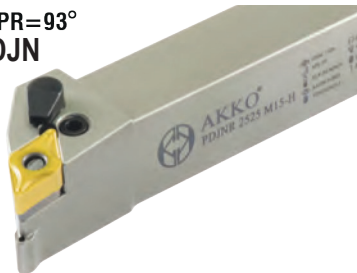

KAPR=95°



Référence	HF=H	B	LF	WF	Code R	Code L	Prix promo € HT
TCLNR/L 2020 K12-H	20	20	125	25	098006	098007	102,01
TCLNR/L 2525 M12-H	25	25	150	32	098008	098009	103,91
TDJNR/L 2020 K15-H	20	20	125	25	098012	098013	102,01
TDJNR/L 2525 M15-H	25	25	150	32	098014	098015	103,91
TDNN 2525 M15-H	25	25	150	32	098018		103,91
TSDNN 2525 M12-H	25	25	150	25	098019		103,91
TSDNN 2525 M15-H	25	25	150	12,7	098021		109,11
TSSNR/L 2525 M12-H	25	25	150	32	098024	098025	103,91
TSSNR/L 2525 M15-H	25	25	150	40	098028	098029	109,11
TTJNR/L 2525 M16-H	25	25	150	32	098034	098035	103,91
TTJNR/L 2525 M22-H	25	25	150	40	098038	-	103,91
TVVNN 2020 K16-H	20	20	125	10	098041		102,01
TVVNN 2525 M16-H	25	25	150	12,7	098042		103,91
TWLNRL/L 2020 K08-H	20	20	125	25	098043	098044	102,01
TWLNRL/L 2525 M08-H	25	25	150	32	098045	098046	103,91

Référence	HF=H	B	LF	WF	Code R	Code L	Prix promo € HT
PCLNR/L 2020 K12-H	20	20	125	25	098049	098057	75,34
PCLNR/L 2525 M12-H	25	25	150	32	098051	098059	77,30
PDJNR/L 2020 K15-H	20	20	125	25	098050	098058	75,34
PDJNR/L 2525 M15-H	25	25	150	32	098052	098060	77,30
PDNN 2525 M15-H	25	25	150	32	098063		77,30
PWLNRL/L 2020 K08-H	20	20	125	25	098064	098065	75,34
PWLNRL/L 2525 M08-H	25	25	150	32	098066	098067	77,30

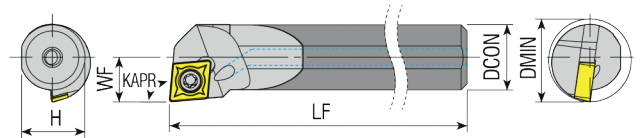

Référence	DCON	H	LF	WF	DMIN	Code R	Code L	Prix promo € HT
C04G SCLCR/L 03	4	3,7	90	2,5	≥5	098068	-	69,82
C05H SCLCR/L 03	5	4,7	100	3	≥6	098069	-	77,18
C06J SCLCR/L 04	6	5,7	110	3,5	≥7	098070	-	93,05
C07K SCLCR/L 04	7	6,7	125	4	≥8	098071	-	107,17
C06J SCLCR/L 06	6	5,7	110	4,5	≥8	098072	098073	100,47
E08K SCLCR/L 06	8	7,5	125	6	≥11	098074	098075	118,83
E10M SCLCR/L 06	10	9,5	150	7	≥13	098076	098077	177,17
E12Q SCLCR/L 06	12	11	180	9	≥16	098078	098079	263,71
E16R SCLCR/L 09	16	15	200	11	≥20	098080	098081	355,67
E20S SCLCR/L 09	20	19	250	13	≥24	098082	098083	675,32

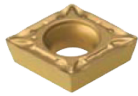

PLAQUETTES	Code	Prix promo € net HT
CCET 030102L PC9030	079208	12,79
CCET 0301005L PC9030	079209 *	12,79
CCET 040102L PC9030	079210	12,79
CCET 0401005L PC9030	079211 *	12,79



| DANS LA LIMITE DES STOCKS DISPONIBLES |

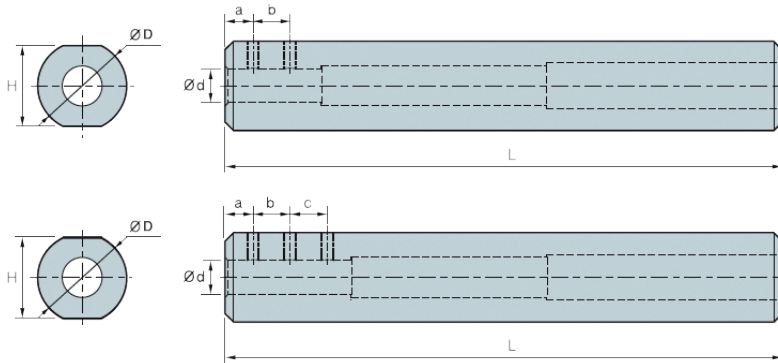

PORTE BARRE ALESAGE MINI - SL160...

D = diamètre porte-outil
d = diamètre outil

Ø d	a	b	c	Ø D	H	L	VIS	CLE	MANCHON	Code	Prix promo € net HT
4	5	6		16	14	100	M4	HW20L	SL1604	090110	115,72
5	5	8		16	14	100	M4	HW20L	SL1605	090111	115,72
6	5	6	6	16	14	100	M4	HW20L	SL1606	090112	115,72

GORGES ET TRONÇONNAGE AKKO

Plaquettes compatibles MGM

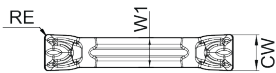
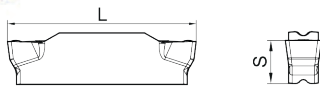
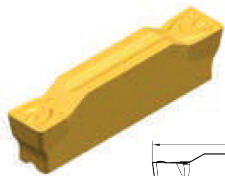

Référence	CW±0.05	RE±0.05	L	W1	S	AP1225		AA4230	
						Code	Prix promo € HT	Code	Prix promo € HT
AGD2002-MT	2.0	0.2	16.0	1.2	3.5	098236	10,30	098239	10,30
AGD3004-MT	3.0	0.4	21.2	2.35	4.8	098237	11,30	098240	11,30
AGD4004-MT	4.0	0.4	21.0	3.3	4.8	098238	12,30	098241	12,30

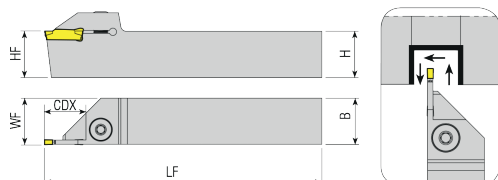

Référence	HF=H	B	LF	WF	CDX	Code R	Code L	Prix promo € HT
ADKT-K-R/L-2020-2-T15	20	20	150	20,3	15	098242	098243	68,00
ADKT-K-R/L-2525-2-T15	25	25	150	25,3	15	098244	098245	68,80
ADKT-K-R/L-2020-3-T20	20	20	125	20,3	20	098246	098247	68,00
ADKT-K-R/L-2020-3-T28	20	20	125	20,3	28	098248	098249	88,80
ADKT-K-R/L-2020-4-T20	20	20	125	20,4	20	098250	098251	68,00
ADKT-K-R/L-2020-4-T25	20	20	125	20,4	25	098252	098253	81,60
ADKT-K-R/L-2525-4-T22	25	25	150	25,4	22	098254	098255	68,80
ADKT-K-R/L-2525-3-T22	25	25	150	25,3	22	098385	098386	55,89

PORTE-OUTILS AKKO

Plaquettes compatibles
R390..

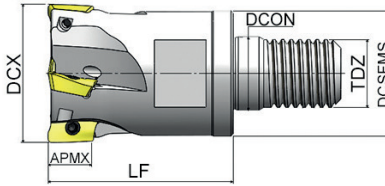
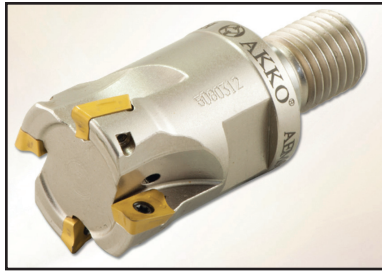

R390.11T3

DC	ZEFP	DCSFMS	TDZ	LF	DCON	APMX	Articles	Prix tarif € net HT
16	2	14,75	M08	30	8,5	10	M.06.11.06.03	134,30
20	3	18	M10	30	10,5	10	M.06.11.06.02	155,80
25	3	21	M12	35	12,5	10	M.06.11.06.01	162,00
32	4	29	M16	43	17	10	M.06.11.06.04	175,30

Plaquettes compatibles
R390..



R390.11T3

DC	ZEFP	DCON	LF	APMX	Articles	Prix tarif € net HT
40	5	16	40	10	M.06.02.22.07	129,20
50	6	22	40	10	M.06.02.22.08	154,80
63	7	22	40	10	M.06.02.22.09	177,40
80	9	27	50	10	M.06.02.22.10	231,70

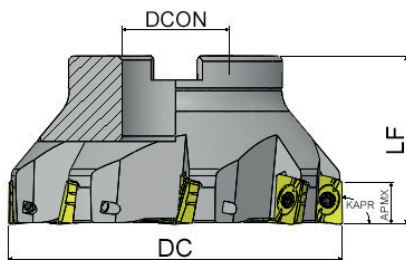

R390.1704

DC	ZEFP	DCON	LF	APMX	Articles	Prix tarif € net HT
40	4	16	40	15,4	M.06.02.22.01	129,20
50	5	22	40	15,4	M.06.02.22.02	154,80
63	6	22	40	15,4	M.06.02.22.03	177,40
80	7	27	50	15,4	M.06.02.22.04	202,00
100	8	32	50	15,4	M.06.02.22.05	246,00
125	9	40	63	15,4	M.06.02.22.06	323,90

Plaquettes compatibles
AP..16

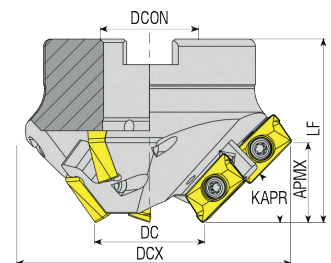

Référence	ZEFP Totale	Effective	KAPR	DC	DCX	DCON	APMX	LF	Code	Prix promo € HT
AHM15-AP16-D35x93-A27-A0306H	6	3	15	35	93	27	8	50	098154	245,53
AHM30-AP16-D35x87-A27-A0306H	6	3	30	35	87	27	15	50	098155	245,53
AHM45-AP16-D35x77-A27-A0306H	6	3	45	35	77	27	21,5	50	098156	245,53
AHM60-AP16-D35x65-A22-A0306H	6	3	60	35	65	22	26,5	50	098157	245,53
AHM75-AP16-D35x50-A22-A0306H	6	3	75	35	50	22	29,5	50	098158	245,53

PORTE-OUTILS AKKO

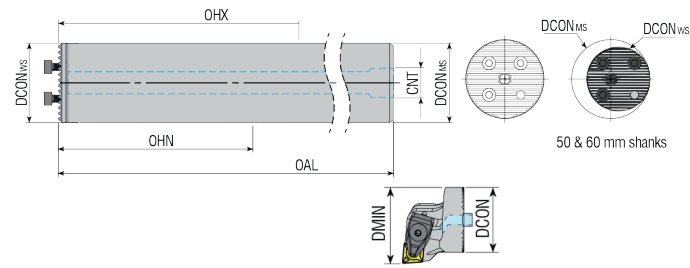

Informations techniques

DCONMS	DCONWS	OAL	OHN	OHX	CNT	DCON	DMIN	Code	Prix promo € HT
25	25	255	88	158	G1/4	25	32	098084	941,16
32	32	320	100	192	G3/8	32	40	098085	1079,26
40	40	408	128	248	G1/2	40	50	098086	1217,28
50	40	519	168	318	G1/2	40	63	098087	1500,85
60	40	628	208	388	G3/4	40	80	098088	1778,41

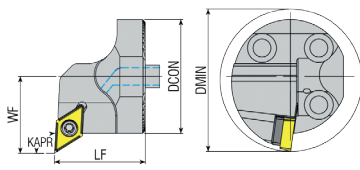

DCON	LF	WF	DMIN	Code R	Code L	Prix promo € HT
25	23	17	32	098089	098090	144,76
32	32	22	40	098091	098092	173,00
40	32	27	50	098093	098094	173,00

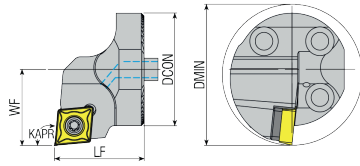

DCON	LF	WF	DMIN	Code R	Code L	Prix promo € HT
25	23	17	32	098095	098096	144,76
32	32	22	40	098097	098098	173,00
40	32	27	50	098099	098100	173,00

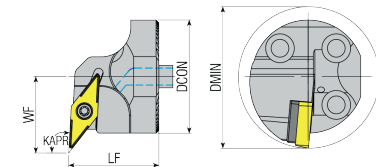

DCON	LF	WF	DMIN	Code R	Code L	Prix promo € HT
25	23	17	32	098101	098102	144,76
32	32	22	40	098103	098104	173,00
40	32	27	50	098105	098106	173,00

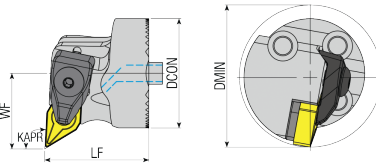

DCON	LF	WF	DMIN	Code R	Code L	Prix promo € HT
32	32	22	40	098107	098108	173,00
40	38	27	50	098109	098110	173,00

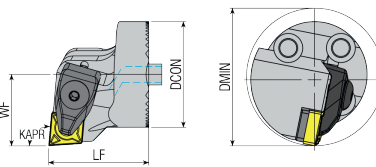

DCON	LF	WF	DMIN	Code R	Code L	Prix promo € HT
32	32	22	40	098111	098112	173,00
40	38	27	50	098113	098114	173,00

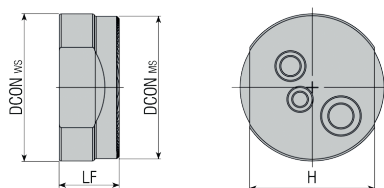

DCONWS	DCONMS	LF	H	Code	Prix promo € HT
28	25	15	22	098115	40,12
53	40	20	35	098116	52,72

PORTE-OUTILS AKKO

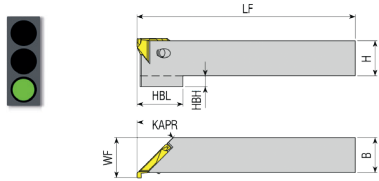

Référence	H	B	WF	LF	HBL	HBH	KAPR	Code R	Code L	Prix promo € HT
AAUT-T20-R/L-1616-45	16	16	18,3	125	21	5	45°	098162	098163	60,45
AAUT-T20-R/L-2020-45	20	20	22,3	125	21	5	45°	098164	098165	61,08
AAUT-T20-R/L-2525-45	25	25	27,3	150	-	-	45°	098166	098167	62,35

Référence	CW	S	RE	CDX	DMIN	Cdtnmt.	Code R	Code L	Prix promo € HT
T20.00.0815.45.04R/L	1,5	3,25	0,4	1,6	8	10	098168	098169	47,41
T20.00.1220.45.05R/L	2,0	3,25	0,5	1,8	12	10	098170	098171	47,41
T20.00.2024.45.06R/L	2,4	3,25	0,6	2,0	20	10	098172	098173	47,41
T20.00.1220.45.10R/L	2,0	3,25	1,0	1,8	12	10	098174	098175	59,05

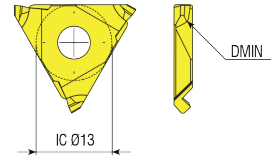

Déconditionnement
Majoration 15 %

PLAQUETTES | PLAQUETTES CBN MULTINSERT (CONDITIONNEMENT PAR 1)



Nb insert	Désignation	Code	Prix tarif € HT
2	CCGW 060204 MHN20C	079008	28,00
2	CCGW 060204 MHN30C	079034	28,00
2	CCGW 060208 MHN20C	079011	28,00
2	CCGW 060208 MHN30C	079035	28,00
2	CCGW 09T304 MHN20C	079013	28,00
2	CCGW 09T304 MHN30C	079036	28,00
2	CCGW 09T308 MHN20C	079009	28,00
2	CCGW 09T308 MHN30C	079037	28,00
2	CNGA 120404 MHN20C	079054	28,00
2	CNGA 120404 MHN30C	079055	56,00
2	CNGA 120408 MHN10C	079004	28,00
4	CNGA 120408 MHN20C	079005	56,00
4	CNGA 120408 MHN30C	079056	56,00
2	DCGW 070204 MHN20C	079038	28,00
2	DCGW 070204 MHN30C	079045	28,00
2	DCGW 070208 MHN20C	079039	28,00
2	DCGW 070208 MHN30C	079046	28,00
2	DCGW 11T304 MHN20C	079043	28,00
2	DCGW 11T304 MHN30C	079047	28,00

Nb insert	Désignation	Code	Prix tarif € HT
2	DCGW 11T308 MHN20C	079044	28,00
2	DCGW 11T308 MHN30C	079048	28,00
2	DNGA 150604 MHN20C	079015	28,00
2	DNGA 150604 MHN30C	079057	28,00
2	DNGA 150608 MHN20C	079017	28,00
2	DNGA 150608 MHN30C	079058	28,00
3	TNGA 160404 MHN20C	079023	42,00
3	TNGA 160408 MHN20C	079019	42,00
3	TNGA 160408 MHN30C	079077	42,00
3	WNGA 080404 MHN20C	079024	42,00
3	WNGA 080404 MHN30C	079078	42,00
3	WNGA 080408 MHN20C	079025	42,00
3	WNGA 080408 MHN30C	079079	42,00

MHN10C : SANS CHOC
MHN20C : OPÉRATION MIXTE
MHN30C : CHOC

PLAQUETTES | KORLOY - PLAQUETTES ALUMINIUM (CONDITIONNEMENT PAR 10)

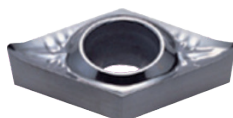

ALUMINIUM TOURNAGE POSITIVE

Désignation	Code	€ net HT
CCGT 060202 AK H01	079016	10,45
CCGT 060204 AK H01	079010	10,45
CCGT 09T302 AK H01	079018	12,35
CCGT 09T304 AK H01	079012	12,35
CCGT 09T308 AK H01	079020	12,35
CCGT 120404 AK H01	079014	13,80
DCGW 070202 AK H01	079111	10,45
DCGW 070204 AK H01	079030	10,45
DCGW 11T302 AK H01	079112	12,35
DCGW 11T304 AK H01	079032	12,35
TCGT 110202 AK H01	079752	10,75
TCGT 110204 AK H01	079250	10,75
TCGT 16T304 AK H01	079251	13,55
VCGT 110304 AK H01	079110	12,99
VCGT 160404 AK H01	079120	14,76

ALUMINIUM TOURNAGE NÉGATIVE

Désignation	Code	€ net HT
CNMG 120404 HA H01	079113	7,34
CNMG 120408 HA H01	079230	7,34
WNMG 060404 HA H01	079115	6,12
WNMG 060408 HA H01	079116	6,12
WNMG 080404 HA H01	079810	7,34
WNMG 080408 HA H01	079114	7,34

ALUMINIUM FRAISAGE

Désignation	Code	€ net HT
APKT 1604 PDR P K10M	079001	13,69

Pas de déconditionnement

PLAQUETTES | KORLOY - PLAQUETTES ISO TOURNAGE (CONDITIONNEMENT PAR 10)

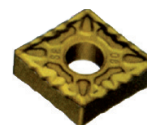

Désignation	Code	€ net HT
CNMG120408-MP NC3225	P15-P25 ACIER	0800014 8,69
DNMG150608-MP NC3225	P15-P25 ACIER	0800015 12,32
WNMG060408-MP NC3225	P15-P25 ACIER	0800016 7,28
WNMG080408-MP NC3225	P15-P25 ACIER	0800017 8,69
CNMG120408-MM NC9125	M20-M30 INOX	0800018 8,69
DNMG150608-MM NC9125	M20-M30 INOX	0800019 12,32
WNMG060408-MM NC9125	M20-M30 INOX	0800020 7,12

PLAQUETTES TOURNAGE	Code	Prix tarif € HT
CCGT 060204 AK PC8110	080563	12,34
CCGT 09T304 AK PC8110	080561	14,57
CCMT 060204 HMP PC8110	080472	7,19
CCMT 09T304 HMP PC8110	080492	8,43

Pas de déconditionnement

PLAQUETTES | PLAQUETTES DE FRAISAGE (CONDITIONNEMENT PAR 10)



PLAQUETTES FRAISAGE	Code	Prix tarif € HT
APKT 1003PDR.I52 T528N	088402	15,71
APMT 1604 PDR.I52 T528N	088401	16,93

Pas de déconditionnement

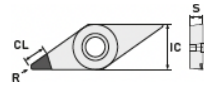
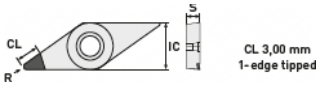

Désignation	IC	S	R	Code	€ net HT	Désignation	IC	S	R	Code	€ net HT
PL VCGT 110302 FN CVD	6,35	3,2	0,20	079817	58,55	PL VBGW 110202 FN CVD	6,35	2,2	0,20	079831	45,00
PL VCGW 110304 FN CVD	6,35	3,2	0,40	079818	45,00	PL VBGW 110204 FN CVD	6,35	2,2	0,40	079832	45,00
PL VCGW 110308 FN CVD	6,35	3,2	0,80	079819	45,00	PL VBGW 110208 FN CVD	6,35	2,2	0,80	079833	45,00
PL VCGT 160402 FN CVD	9,525	4,8	0,20	079820	45,00	PL VBGW 160402 FN CVD	9,525	4,8	0,20	079834	45,00
PL VCGW 160404 FN CVD	9,525	4,8	0,40	079821	45,00	PL VBGW 160404 FN CVD	9,525	4,8	0,40	079835	45,00
PL VCGW 160408 FN CVD	9,525	4,8	0,80	079822	45,00	PL VBGW 160408 FN CVD	9,525	4,8	0,80	079836	45,00
PL VCGW 160412 FN CVD	9,525	4,8	1,20	079823	45,00	PL VBGW 160412 FN CVD	9,525	4,8	1,20	079837	45,00
PL VCGW 110302 FN PCD	6,35	3,2	0,20	079824	22,00	PL VBGT 110202 FN PCD	6,35	2,2	0,20	079838	27,00
PL VCGW 110304 FN PCD	6,35	3,2	0,40	079825	22,00	PL VBGT 110204 FN PCD	6,35	2,2	0,40	079839	27,00
PL VCGW 110308 FN PCD	6,35	3,2	0,80	079826	22,00	PL VBGT 110208 FN PCD	6,35	2,2	0,80	079840	27,00
PL VCGW 160402 FN PCD	9,525	4,8	0,20	079827	22,00	PL VBGW 160402 FN PCD	9,525	4,8	0,20	079841	22,00
PL VCGW 160404 FN PCD	9,525	4,8	0,40	079828	22,00	PL VBGW 160404 FN PCD	9,525	4,8	0,40	079842	22,00
PL VCGW 160408 FN PCD	9,525	4,8	0,80	079829	22,00	PL VBGW 160408 FN PCD	9,525	4,8	0,80	079843	22,00
PL VCGT 160412 FN PCD	9,525	4,8	1,20	079830	27,00	PL VBGT 160412 FN PCD	9,525	4,8	1,20	079844	27,00

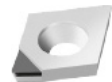
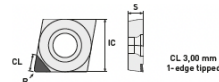
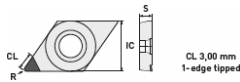

Désignation	IC	S	R	Code	€ net HT	Désignation	IC	S	R	Code	€ net HT
PL DCGW 070202 FN CVD	6,35	2,4	0,20	079845	45,00	PL CCGW 060202 FN CVD	6,35	2,4	0,20	079859	45,00
PL DCGW 070204 FN CVD	6,35	2,4	0,40	079846	45,00	PL CCGW 060204 FN CVD	6,35	2,4	0,40	079860	45,00
PL DCGW 070208 FN CVD	6,35	2,4	0,80	079847	45,00	PL CCGW 060208 FN CVD	6,35	2,4	0,80	079861	45,00
PL DCGW 11T302 FN CVD	9,525	4	0,20	079848	45,00	PL CCGW 09T302 FN CVD	9,525	4	0,20	079862	45,00
PL DCGW 11T304 FN CVD	9,525	4	0,40	079849	45,00	PL CCGW 09T304 FN CVD	9,525	4	0,40	079863	45,00
PL DCGW 11T308 FN CVD	9,525	4	0,80	079850	45,00	PL CCGW 09T308 FN CVD	9,525	4	0,80	079864	45,00
PL DCGW 11T312 FN CVD	9,525	4	1,20	079851	45,00	PL CCGW 09T312 FN CVD	9,525	4	1,20	079865	45,00
PL DCGW 070202 FN PCD	6,35	2,4	0,20	079852	22,00	PL CCGW 120402 FN CVD	12,70	4,8	0,20	079866	45,00
PL DCGW 070204 FN PCD	6,35	2,4	0,40	079853	22,00	PL CCGW 120404 FN CVD	12,70	4,8	0,40	079867	45,00
PL DCGW 070208 FN PCD	6,35	2,4	0,80	079854	22,00	PL CCGW 120408 FN CVD	12,70	4,8	0,80	079868	45,00
PL DCGW 11T302 FN PCD	9,525	4	0,20	079855	22,00	PL CCGW 060202 FN PCD	6,35	2,4	0,20	079869	22,00
PL DCGW 11T304 FN PCD	9,525	4	0,40	079856	22,00	PL CCGW 060204 FN PCD	6,35	2,4	0,40	079870	22,00
PL DCGW 11T308 FN PCD	9,525	4	0,80	079857	22,00	PL CCGW 060208 FN PCD	6,35	2,4	0,80	079871	22,00
PL DCGT 11T312 FN PCD	9,525	4	1,20	079858	29,00	PL CCGT 09T302 FN PCD	9,525	4	0,20	079872	22,00
						PL CCGW 09T304 FN PCD	9,525	4	0,40	079873	22,00
						PL CCGW 09T308 FN PCD	9,525	4	0,80	079874	22,00
						PL CCGT 09T312 FN PCD	9,525	4	1,20	079875	29,00
						PL CCGT 120402 FN PCD	12,70	4,8	0,20	079876	29,00
						PL CCGW 120404 FN PCD	12,70	4,8	0,40	079877	22,00
						PL CCGW 120408 FN PCD	12,70	4,8	0,80	079878	22,00

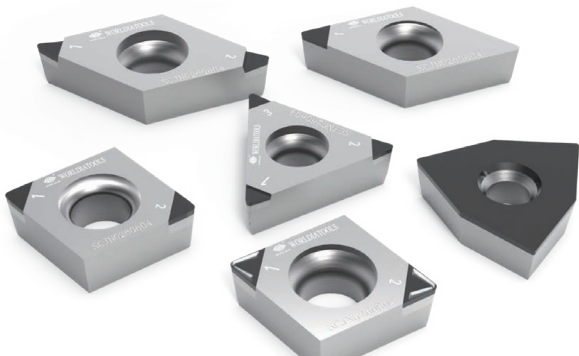

CVD-D

Idéal pour l'usinage de :
 PMMA / ALUMINIUM < 10% Si | Carbure | Céramique | Composites
 GFRP-CFRP | Cuivre, alliages cuivre | Bronze, céramique bronze |
 Magnésium | Plastique | Argent, or, platine | Titane | Zirconium

PCD

Idéal pour l'usinage de :
 ALUMINIUM < 10% Si | Bronze | Cuivre, alliages de cuivre | Graphite |
 Magnésium | PEEK | Alliages tungsten

PLAQUETTES | FILETAGE INOX ET PORTE-OUTILS

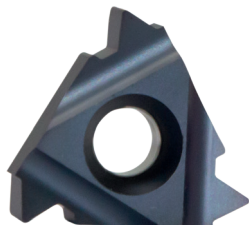

Désignation	Code	Désignation	Code	Désignation	Code
11ER1.5ISOXTIALN	076632	16ER1.0ISOXTIALN	076640	16IR0.8ISOXTIALN	076650
11IR0.8ISOXTIALN	076633	16ER1.25ISOXTIALN	076660	16IR1.0ISOXTIALN	076651
11IR1.0ISOXTIALN	076634	16ER1.5ISOXTIALN	076641	16IR1.5ISOXTIALN	076652
11IR1.5ISOXTIALN	076635	16ER1.75ISOXTIALN	076661	16IR2.0ISOXTIALN	076653
11IR2.0ISOXTIALN	076667	16ER2.0ISOXTIALN	076642	16IR2.5ISOXTIALN	076654
16ER0.35ISOXTIALN	076657	16ER2.5ISOXTIALN	076643	16IR3.0ISOXTIALN	076655
16ER0.45ISOXTIALN	076658	16ER3.0ISOXTIALN	076644	16IR3.5ISOXTIALN	076656
16ER0.5ISOXTIALN	076636	16ER3.5ISOXTIALN	076645	16IR0.35ISOXTIALN	076662
16ER0.6ISOXTIALN	076637	16IR0.4ISOXTIALN	076646	16IR0.45ISOXTIALN	076663
16ER0.7ISOXTIALN	076638	16IR0.5ISOXTIALN	076647	16IR0.75ISOXTIALN	076664
16ER0.75ISOXTIALN	076659	16IR0.6ISOXTIALN	076648	16IR1.25ISOXTIALN	076665
16ER0.8ISOXTIALN	076639	16IR0.7ISOXTIALN	076649	16IR1.75ISOXTIALN	076666



CONDITIONNEMENT PAR 10
Prix au détail : 16 € HT



Désignation	Code	Prix promo € net HT
PO FIL. EXTER. SER 2020 K16	076450	62,57
PO FIL. EXTER.SER 2525 M16	076451	73,87
PO FIL. INTER. SIR 0013 M16	076452	61,18
PO FIL. INTER. SIR 0016 P16	076453	61,18
PO FIL. INTER. SIR 0025 R16	076454	91,15
PO FIL. INTER. SIR 0032 S16	076455	97,35
PO FILETER INTER. SIR 0020 P16	076901	66,48

PLAQUETTES | FILETAGE UNIVERSEL



Désignation	Code	Désignation	Code	Désignation	Code	Désignation	Code
16ER 0.50 ISO FC TIALN	076400	16ER 9W FC TIALN	076109	16IR 28W FC TIALN	076130	16IR 12UN FC TIALN	076099
16ER 0.70 ISO FC TIALN	076402	16ER 11W FC TIALN	076111	16ER 8UN FC TIALN	076080	16IR 14UN FFC TIALN	076100
16ER 0.75 ISO FC TIALN	076401	16ER 14W FC TIALN	076112	16ER 9UN FC TIALN	076081	16IR 16UN FC TIALN	076101
16ER 0.80 ISO FC TIALN	076403	16ER 16W FC TIALN	076113	16ER 10UN FC TIALN	076082	16IR 18UN FC TIALN	076102
16ER 1.00 ISO FC TIALN	076404	16ER 18W FC TIALN	076114	16ER 11,5 UN FC TIALN	076084	16IR 20UN FC TIALN	076103
16ER 1.25 ISO FC TIALN	076405	16ER 19W FC TIALN	076115	16ER 11UN FC TIALN	076083	16IR 24UN FC TIALN	076104
16ER 1.50 ISO FC TIALN	076406	16ER 20W FC TIALN	076116	16ER 12UN FC TIALN	076085	16IR 27UN FC TIALN	076105
16ER 1.75 ISO FC TIALN	076407	16ER 24W FC TIALN	076117	16ER 13UN FC TIALN	076086	16IR 28UN FC TIALN	076106
16ER 2.0 ISO FC TIALN	076409	16ER 28W FC TIALN	076118	16ER 14UN FC TIALN	076087	16ER A55 FC TIALN	076412
16ER 2.5 ISO FC TIALN	076410	16IR 7W FC TIALN	076119	16ER 16UN FC TIALN	076088	16ER A60 FC TIALN	076413
16ER 3.0 ISO FC TIALN	076411	16IR 8W FC TIALN	076120	16ER 18UN FC TIALN	076089	16ER AG55 FC TIALN	076414
16IR 1.0 ISO FC TIALN	076418	16IR 9W FC TIALN	076121	16ER 20UN FC TIALN	076090	16ER AG60 FC TIALN	076415
16IR 1.25 ISO FC TIALN	076419	16IR 10W FC TIALN	076122	16ER 24UN FC TIALN	076091	16ER G55 FC TIALN	076416
16IR 1.5 ISO FC TIALN	076420	16IR 11W FC TIALN	076123	16ER 27UN FC TIALN	076092	16ER G60 FC TIALN	076417
16IR 1.75 ISO FC TIALN	076430	16IR 14W FC TIALN	076124	16ER 28UN FC TIALN	076093	16IR A55 FC TIALN	076424
16IR 2.0 ISO FC TIALN	076421	16IR 16W FC TIALN	076125	16IR 8UN FC TIALN	076094	16IR A60 FC TIALN	076425
16IR 2.5 ISO FC TIALN	076422	16IR 18W FC TIALN	076126	16IR 9UN FC TIALN	076095	16IR AG55 FC TIALN	076426
16IR 3.0 ISO FC TIALN	076423	16IR 19W FC TIALN	076127	16IR 10UN FC TIALN	076096	16IR AG60 FC TIALN	076427
16ER 7W FC TIALN	076107	16IR 20W FC TIALN	076128	16IR 11,5UN FC TIALN	076098	16IR G55 FC TIALN	076428
16ER 8W FC TIALN	076108	16IR 24W FC TIALN	076129	16IR 11UN FC TIALN	076097	16IR G60 FC TIALN	076429

CONDITIONNEMENT PAR 10
Prix au détail :
- ISO et W = 14 € HT
- UN = 17 € HT



SERVANTES ET SUPPORTS CONES

SUPPORT ÉTABLI

Outils	Places	Référence	Code	Promo € net ht
SK30/BT30	24	WZ-WR3K2-SK30	403001	294,80
SK40/BT40	21	WZ-WR3K2-SK40	403002	294,80
SK50/BT50	15	WZ-WR3K2-SK50	403003	294,80
HSK63	18	WZ-WR3K2-HSK63	403004	312,71



RACK CONES

Outils	Places	Référence	Code	Promo € net ht
SK30/BT30	8	WZ-WRK2-SK30	403005	87,60
SK40/BT40	7	WZ-WRK2-SK40	403006	87,60
SK50/BT50	6	WZ-WRK2-SK50	403007	87,60
HSK63	6	WZ-WRK2-HSK63	403008	94,60

SUPPORT CONES

Outils	Référence	Code	Promo € net ht
SK30/BT30	WZ-R2-SK30	403009	8,00
SK40/BT40	WZ-R2-SK40	403010	8,00
SK50/BT50	WZ-R2-SK50	403011	8,00
HSK63	WZ-R2-HSK63	403012	8,00

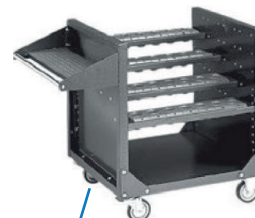

SERVANTE COMPLÈTE

Outils	Places	kg	Référence	Code	Promo € net ht
SK30/BT30	32	51	WZ-WW-SK30	403013	621,60
SK40/BT40	28	51	WZ-WW-SK40	403014	621,60
SK50/BT50	20	51	WZ-WW-SK50	403015	621,60
HSK63	24	51	WZ-WW-HSK63	403016	621,60



CHASSE CONES ET NETTOYEURS

CHASSE CONE



Taille	L	Référence	Code	Promo € net ht
MK0	90	01-2000	428001	4,55
MK1+2	140	01-2002	428002	3,90
MK3	190	01-2003	428004	5,33
MK4	225	01-2004	428005	6,76
MK5+6	265	01-2005	428006	10,92

SK

Taille	Référence	Code	Promo € net ht
SK30	09-76200030	431003B	14,96
SK40	09-76200040	431004B	14,96
SK50	09-76200050	431005B	21,72



MT

Taille	Référence	Code	Promo € net ht
MK1	09-76200001	431006B	10,40
MK2	09-76200002	431007B	9,10
MK3	09-76200003	431008B	11,06
MK4	09-76200004	431009B	14,70
MK5	09-76200005	431010B	20,68
MK6	09-76200006	431011B	46,28



CHASSE CONE SEMI AUTOMATIQUE



Taille	L	Référence	Code	Promo € net ht
MK1+2+3	317	01-8003	428011	51,61
MK4+5+6	380	01-8006	428012	64,48

HSK

Taille	Référence	Code	Promo € net ht
HSK32	09-76205032	431012B	60,58
HSK40	09-76205040	431013B	54,48
HSK50	09-76205050	431014B	57,20
HSK63	09-76205063	431015B	57,20
HSK80	09-76205080	431016B	74,24
HSK100	09-762050100	431017B	79,18



ER

Taille	Référence	Code	Promo € net ht
ER16	09-76202016	431018B	21,20
ER20	09-76202020	431019B	25,88
ER25	09-76202025	431020B	30,42
ER32	09-76202032	431021B	36,02
ER40	09-76202040	431022B	41,60



AFFUTEUSE DE FORETS



FTX-13-AB
499000*
600 €

Le saviez-vous ?

Nous vendons aussi
les meules
Code : 499002 / 499003

CBN14
192,16 € HT

SD14
221,63 € HT



DATOS TÉCNICOS / TECHNICAL SPECIF. / CARACT. TECHNIQUES

Alimentación / Voltage / Alimentation		220V - F1
Potencia / Power / Puissance	W	180
Velocidad / Speed / Vitesse	rpm	4800
Capacidad afilado / Grinding range / Gamme de meulage	mm	Ø3 - Ø13
Ángulo del afilado / Point angle		100° (95°) - 135°
Peso / Weight / Poids	kg.	10
Dimensiones / Dimensions / Dimensions	mm.	320x180x190
Código EAN / EAN code		8423640153141



| LIVRÉE AVEC MEULE POUR FORÊTS HSS - MEULE DIAMANT POUR FORÊT CARBURE EN OPTION |

COLONNE DE MESURE | 1D PALPAGE MOTORISÉ OPTIMA-M



Désignation	Référence	Code
COLONNE OPTIMA M450	33 13 10250	510000
COLONNE OPTIMA M700	33 13 10260	510001

Livrée avec :

- 1 Étalon de calibration
- 1 Support de palpeur
- 1 Palpeur touche carbure Ø6
- 1 Poignée
- Chargeur, housse et manuel d'utilisation
- Logiciel (en anglais) + câble USB pour exports des résultats vers un PC

PRIX SUR DEMANDE

Caractéristiques Techniques :

Modèles	Optima-M 450	Optima-M 700
Code	33 13 10250	33 13 10260
Course de mesure	450 mm	700 mm
Plage de mesure avec inversion du palpeur	765/830 mm	1015/1080 mm
Résolution paramétrable	0,010 - 0,005 - 0,001 - 0,0005 mm	
Répétabilité	Surface plane ≤ 0,0015 mm Surface cylindrique ≤ 0,0030 mm	
Vitesse maxi de déplacement	Jusqu'à 600 mm/sec	
Force de mesure	1,2 N ± 0,2	
Incertitude de mesure*	2,5 + L / 250 µm (L=longueur en mm)	
Perpendicularité**	6,5 µm	10 µm
Déplacement colonne	Sur coussin d'air (compresseur intégré)	
Autonomie sur accu Li ION	20 Heures	
Température d'utilisation	10°C à 40°C	
Poids	23 kg	27 kg
Palpeur standard	Bille carbure Ø 6 x 48 mm	



Poids nets



✓ Palpage motorisé assurant une bonne répétabilité



✓ Utilisation simple & intuitive, touche à effleurement



✓ 5 derniers résultats visibles à l'écran sous forme d'icône



✓ Traçabilité : Export des résultats vers PC via logiciel inclus

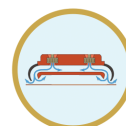

✓ Déplacement sur coussin d'air pour faciliter le mouvement sur le marbre

THERMOGRIP | ISG 1200



ISG 1200
prix sur
demande *

Référence	Article
ISG1200TLK-8-BIL-D	5190238
T3-W/HSK100	6725938
T3-W/HSK32	6725939
T3-W/HSK40	6725940
T3-W/HSK50	6725941
T3-W/HSK63	6725942
T3-W/HSK80	6725943
T3-W/SK40	6725944
T3-W/SK50	6725945
T3-K/12,1-16	6725951
T3-K/16,1-22	6725953
T3-K/22,1-32	6725954
T3-K/6-9	6725955
T3-K/9,1-12	6725956
T3-W/SK30	6725958

- Saisie aisée des paramètres de frettage en scannant les codes-barres.
- La technique d'induction à économie d'énergie garantit une longue durée de vie des outils
- Centrage précis de l'outil
- Faible encombrement et utilisation mobile
- Force de maintien maximale et résistance durable, même dans un environnement huileux
- Plage de serrage diamètre 3 à 32 mm pour tous les mandrins de frettage T, TSF, TB et TER (HSS diamètre 10 - 20 mm / HM diamètre 3 - 32 mm)
- Refroidissement par air pulsé (support de cônes disponible en option)
- Longueur maximale de l'outil à partir du référentiel du cône : 450 mm HSK-A63
- Longueur de refroidissement : 200 mm

*jusqu'à épuisement des stocks

FRETTAGE D'OUTILS CARBURE - DIAMÈTRE DE QUEUE D'OUTIL 3 | 4H4 | 5H5 | 6 à 20 TOLÉRANCE H6
FRETTAGE D'OUTILS ACIER RAPIDE - DIAMÈTRE DE QUEUE D'OUTIL 6 à 20 MM TOLÉRANCE H6

THERMOGRIP | ISG 2430TLK FS



ISG 2430TLK-8FS
780020
prix sur
demande

- Affichage graphique
- Frettage par induction, une station de travail et de refroidissement par ventilation
- Un collier d'induction avec trois disques interchangeable
- Longueur de frettage maximum : 450mm (pour un HSKA63)
- Longueur de refroidissement maximum : 200mm (pour un HSKA63)
- Support de cône jusqu'à HSKA100 ou SA50

ALIMENTATION ÉLECTRIQUE : 3x400 V / 16A (TROIS PHASES + TERRE + NEUTRE)
POIDS APPROXIMATIF : 25 KGS
DIMENSIONS : L 780MM x P 535 MM X H 970 MM

ACCESSOIRES POUR ISG 2430TLK 8 FS

SUPPORT PORTE	OUTIL T3	W / HSK 25	40
SUPPORT PORTE	OUTIL T3	W / HSK 32	
SUPPORT PORTE	OUTIL T3	W / HSK 40	
SUPPORT PORTE	OUTIL T3	W / HSK 50	
SUPPORT PORTE	OUTIL T3	W / HSK 63	
SUPPORT PORTE	OUTIL T3	W / HSK 80	
SUPPORT PORTE	OUTIL T3	W / HSK 100	
SUPPORT PORTE	OUTIL T3	W / SK 30	

ACCESSOIRES POUR ISG 2430TLK 8 FS

SUPPORT PORTE	OUTIL T3	W / SK 40
SUPPORT PORTE	OUTIL T3	W / SK 50
REFROIDISSEUR T3	K/3	5,9
REFROIDISSEUR T3	K/6	9
REFROIDISSEUR T3	K/9,1	12
REFROIDISSEUR T3	K/12,1	16
REFROIDISSEUR T3	K/16,1	22

Compatibles ISG3430

THERMOGRIP | ISG 3430TLK



ISG 3430TLK-11WS
5102054
prix sur
demande

- Ecran graphique
- Frettage de 3-32mm pour des queues d'outil en carbure
- Frettage de 6-32mm pour des queues d'outils en acier
- Livré avec 4 disques de ferrite
- Bobine interchangeable
- Longueur d'outil max : 450mm (avec un attachement en HSKA63)
- Longueur de refroidissement : 200mm (avec un attachement en HSKA63)
- Refroidissement par air pulsé
- Support de cônes : jusqu'à HSKA100 / SA50
- Poids : 69kg
- Alimentation électrique : 400V /16A (3 phases avec Terre et neutre)





elbo controlli **NIKKEN**
rock solid measurement



• **SIMPLE ET RAPIDE**

Le nouveau logiciel qui gère le banc garantit des performances incroyables, en gardant toujours cette touche de simplicité qui distingue les bancs de pré-réglages Elbo Controlli NIKKEN.

• **INTERCHANGEABLE**

L'E236+ utilise le système de broches interchangeable (ISO/BT/HSK/système polygonal, etc.), ce qui évite l'utilisation d'adaptateurs qui peuvent introduire des erreurs.

• **UN NOUVEAU POSITIONNEMENT**

Le nouveau système de positionnement des axes vous aide à visualiser l'arrêt de coupe de votre outil, à mesurer au center de l'écran rapidement et facilement.



| AUTRES MODÈLES, NOUS CONSULTER |

MANDRIN À PINCE 5C

Mandrin à pince 5C
Montage central



C mm	A (Ø) mm	D1 mm	F mm	G mm	B mm	RPM min-1	kg	Référence	Code
4	126	95	108	3 x M8 x 45	107,4	6000	4,5	ZE-SF5C-125	403018

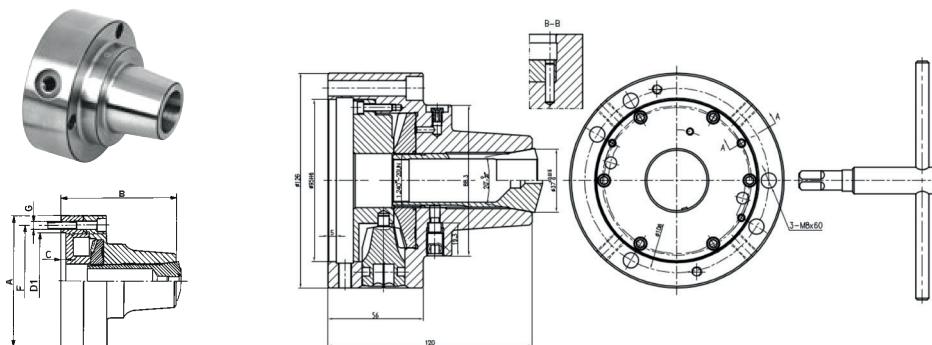

280,98 €
net HT

Pince type 385E (5C)
Pas de 0,5 mm

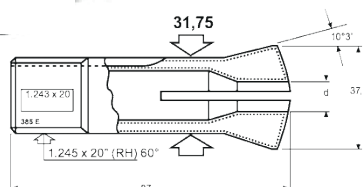

D mm	Référence	Code
3 - 26 mm	06-385E-Ø	420300-420323
27-30 mm	06-385E-Ø	prix sur demande

14 €
net HT

ATTACHEMENT | PINCES ER DIN 6499 | CLASSE 1



PINCES ER16 CLASSE 1

Ø D	Code
3 2	427334B
4 3	427335B
5 4	427336B
6 5	427337B
7 6	427338B
8 7	427339B
9 8	427340B
10 9	427341B

8,40
€ HT

PINCES ER20 CLASSE 1

Ø D	Code	Ø D	Code	Ø D	Code
1 0,5	427350B	4 3	427355B	9 8	427360B
1,5 1	427351B	5 4	427356B	10 9	427361B
2 1	427352B	6 5	427357B	11 10	427362B
2,5 2	427353B	7 6	427358B	12 11	427363B
3 2	427354B	8 7	427359B	13 12	427364B

9,40
€ HT



PINCES ER25 CLASSE 1

Ø D	Code	Ø D	Code	Ø D	Code
1 0,5	427370B	7 6	427378B	15 14	427386B
1,5 1	427371B	8 7	427379B	16 15	427387B
2 1,5	427372B	9 8	427380B	17 16	427366B
2,5 2	427373B	10 9	427381B	18 17	427367B
3 2	427374B	11 10	427382B	19 18	427368B
4,5 3	427375B	12 11	427383B	20 19	427369B
5 4	427376B	13 12	427384B		
6 5	427377B	14 13	427385B		

8,40
€ HT

PINCES ER32 CLASSE 1

Ø D	Code	Ø D	Code	Ø D	Code
2 1,5	427248B	9 8,5	427256B	16 15,5	427263B
3 2,5	427250B	10 9,5	427257B	17 16,5	427264B
4 3,5	427251B	11 10,5	427258B	18 17,5	427265B
5 4,5	427252B	12 11,5	427259B	19 18,5	427266B
6 5,5	427253B	13 12,5	427260B	20 19,5	427267B
7 6,5	427254B	14 13,5	427261B		
8 7,5	427255B	15 14,5	427262B		

7,20
€ HT

ATTACHEMENT | PINCES ER DIN 6499 PRECISION 0,005



PINCES ER16 DE PRÉCISION 5 MICRONS

Ø D	Code	Ø D	Code	Ø D	Code
1,0 0,5	423240	4,5 4,0	423247	8,0 7,5	423254
1,5 1,0	423241	5,0 4,5	423248	8,5 8,0	423255
2,0 1,0	423242	5,5 5,0	423249	9 8,5	423256
2,5 2,0	423243	6,0 5,5	423250	9,5 9,0	423257
3,0 2,5	423244	6,5 6,0	423251	10,0 9,5	423258
3,5 3,0	423245	7,0 6,5	423252		
4,0 3,5	423246	7,5 7,0	423253		

PINCES ER20 DE PRÉCISION 5 MICRONS

Ø D	Code	Ø D	Code
1 0,5	423904	6 5,5	423909
2 1,5	423905	8 7,5	423910
3 2,5	423906	10 9,5	423911
4 3,5	423907	12 11,5	423912
5 4,5	423908		

PINCES ER25 DE PRÉCISION 5 MICRONS

Ø D	Code	Ø D	Code	Ø D	Code
1 0,5	423260	6,5 6,0	423271	12 11,5	423282
1,5 1	423261	7,0 6,5	423272	12,5 12,0	423283
2 1,5	423262	7,5 7,0	423273	13 12,5	423284
2,5 2	423263	8,0 7,5	423274	13,5 13,0	423285
3 2,5	423264	8,5 8,0	423275	14 13,5	423286
3,5 3	423265	9,0 8,5	423276	14,5 14,0	423287
4,0 3,5	423266	9,5 9,0	423277	15 14,5	423288
4,5 4,0	423267	10,0 9,5	423278	15,5 15,0	423289
5 4,5	423268	10,5 10,0	423279	16 15,5	423290
5,5 5,0	423269	11,0 10,5	423280		
6 5,5	423270	11,5 11,0	423281		

PINCES ER32 DE PRÉCISION 5 MICRONS

Ø D	Code	Ø D	Code	Ø D	Code
2 1,5	427248	9 8,5	427256	16 15,5	427263
3 2,5	427250	10 9,5	427257	17 16,5	427264
4 3,5	427251	11 10,5	427258	18 17,5	427265
5 4,5	427252	12 11,5	427259	19 18,5	427266
6 5,5	427253	13 12,5	427260	20 19,5	427267
7 6,5	427254	14 13,5	427261		
8 7,5	427255	15 14,5	427262		



12,50
€ HT

ATTACHEMENT | SERIE PINCES ER16 | ER32 | ER32UP



SERIE PINCES	Code	Prix promo € net HT
SERIE 13 PINCES ER11 Ø 1 7	870361	175,03
SERIE 8 PINCES ER16 DIN6499 CLASSE 1 Ø D 3 10	427996P	68,76
SERIE 18 PINCES ER32 DIN6499 CLASSE 1 Ø D 3 20	427999P	129,31
SERIE 11 PINCES ER EXS20 DIN6499 CLASSE 1 Ø D 3 13	427997B	91,38
SERIE 14 PINCES ER ESX25 DIN6499 CLASSE 1 Ø D 3 16	427998B	113,79



SERIE PINCES	Code	Prix promo € net HT
SERIE 10 PINCES ER16UP PRECISION 5 MICRONS	427904B	197,67
SERIE 12 PINCES ERX20UP PRECISION 5 MICRONS	427905B	222,42
SERIE 14 PINCES ER25UP PRECISION 5 MICRONS	427906B	172,41
SERIE 18 PINCES ER32UP DIN6499 5 micron Ø D 3 20	427903P	219,31

ATTACHEMENT | PINCES ARROSAGE FACE - ER 16 | 25 | 32 JET



PRÉCISION 0,008



PINCES ER16 JET

Ø D	Code
3	800156
4	800157
5	800158
6	800159
7	800160

PINCES ER25 JET

Ø D	Code	Ø D	Code
3	800161	9	800167
4	800162	10	800168
5	800163	11	800169
6	800164	12	800170
7	800165	13	800171
8	800166	14	800172

PINCES ER32 JET

Ø D	Code	Ø D	Code
6	800030	14	800037
7	800031	15	800038
8	800032	16	800039
9	800033	17	800040
10	800034	18	800041
11	800035	19	800042
12	800036	20	800043

ATTACHEMENT | PINCES ARROSAGE FACE - ER 16 | 25 | 32 SUPER JET



PINCE AVEC
CANAL
D'ARROSAGE



PINCES ER16 JET

Ø D	Code
2	800177
3	800178
4	800179
5	800180
6	800181
7	800182
8	800183
9	800184
10	800185

PINCES ER25 JET

Ø D	Code	Ø D	Code
3	800186	10	800193
4	800187	11	800194
5	800188	12	800195
6	800189	13	800196
7	800190	14	800197
8	800191	15	800198
9	800192	16	800199

PINCES ER32 JET

Ø D	Code	Ø D	Code
3	800200	12	800209
4	800201	13	800210
5	800202	14	800211
6	800203	15	800212
7	800204	16	800213
8	800205	17	800214
9	800206	18	800215
10	800207	19	800216
11	800208	20	800217

ATTACHEMENT | PINCES ÉTANCHES MÉCANIQUE - ER 16 | 20 | 25 | 32

PRÉCISION 0,008

PINCES ER16 ÉTANCHE MÉCANIQUE

Ø D	Code
3	800050
4	800051
5	800052
6	800053
7 *	800054
8	800055
9 *	800056
10	800057



PINCES ER20 ÉTANCHE MÉCANIQUE

Ø D	Code	Ø D	Code
3	800065	9 *	800071
4	800066	10	800072
5	800067	11 *	800073
6	800068	12	800074
7 *	800069	13 *	800075
8	800070		



PINCES ER32 ÉTANCHE MÉCANIQUE

Ø D	Code	Ø D	Code
3	800003	12	800012
4	800004	13 *	800013
5	800005	14	800014
6	800006	15 *	800015
7 *	800007	16	800016
8	800008	17 *	800017
9 *	800009	18	800018
10	800010	19 *	800019
11 *	800011	20	800020

PINCES ER25 ÉTANCHE MÉCANIQUE

Ø D	Code	Ø D	Code
3	800080	10	800087
4	800081	11 *	800088
5	800082	12	800089
6	800083	13 *	800090
7 *	800084	14	800091
8	800085	15	800092
9	800086	16	800093



PINCES ER40 ÉTANCHE MÉCANIQUE

* dans la limite des stocks disponibles

ATTACHEMENT | PINCES ETANCHES - ERGM 16 | 25 | 32 TARAUDAGE



PINCES ERGM 16

M	Ø D	Code
3	3,5	800218
3,5	4	800219
4	4,5	800220
4	5	800221
5	5,5	800222
5-6-8	6	800223
5-8	6,3	800224
7-10	7	800225

PINCES ERGM 25

M	Ø D	Code	M	Ø D	Code
3	3,5	800226	7-10	7	800233
3,5	4	800227	8	8	800234
4	4,5	800228	9-12	9	800235
4	5	800229	10	10	800236
5	5,5	800230	14	11	800237
5-6-8	6	800231	12	800238	
5-8	6,3	800232			

PINCES ERGM 32

M	Ø D	Code	M	Ø D	Code
3	3,5	800239	8	8	800247
3,5	4	800240	9-12	9	800248
4	4,5	800241	10	10	800249
4	5	800242	14	11	800250
5	5,5	800243	12	800251	
5-6-8	6	800244	18	14	800252
5-8	6,3	800245	20	16	800253
7-10	7	800246			

ATTACHEMENT | PINCES ETANCHES - 4SR32 | 6SSR12 | 6SR20

MANDRIN FORT SERRAGE 4SR32

Ø D	Code	Ø D	Code
6	800254	16	800264
7	800255	17	800265
8	800256	18	800266
9	800257	19	800267
10	800258	20	800268
11	800259	21	800269
12	800260	22	800270
13	800261	23	800271
14	800262	24	800272
15	800263	25	800273

0,005 MICRONS

MANDRIN HYDRAULIQUE 6SR12

Ø D	Code
3	800274
4	800275
5	800276
6	800277
7	800278
8	800279
10	800280



MANDRIN HYDRAULIQUE 6SR20

Ø D	Code	Ø D	Code
3	800281	11	800289
4	800282	12	800290
5	800283	13	800291
6	800284	14	800292
7	800285	15	800293
8	800286	16	800294
9	800287	17	800295
10	800288	18	800296

0,005 MICRONS



ATTACHEMENT | PINCES ETANCHE AVEC JOINT - ERXG 16 | 20 | 25 | 32

PRÉCISION 0,008



PINCES ÉTANCHE ERXG.16

Ø D	Code	Ø D	Code
3	427320B	7 *	427324B
4	427321B	8	427325B
5	427322B	9 *	427326B
6	427323B	10	427327B

PINCES ÉTANCHE ERXG.25

Ø D	Code	Ø D	Code	Ø D	Code
3	427585B	8	427590B	13 *	427595B
4	427586B	9 *	427591B	14	427596B
5	427587B	10	427592B	15 *	427597B
6	427588B	11 *	427593B	16	427598B
7 *	427589B	12	427594B		



PINCES ÉTANCHE ERXG.20

Ø D	Code	Ø D	Code
3	427389B	9 *	427395B
4	427390B	10	427396B
5	427391B	11 *	427397B
6	427392B	12	427398B
7 *	427393B	13 *	427399B
8	427394B		

PINCES ÉTANCHE ERXG.32

Ø D	Code	Ø D	Code	Ø D	Code
4	427300B	10	427306B	16	427312B
5	427301B	11 *	427307B	17 *	427313B
6	427302B	12	427308B	18	427314B
7 *	427303B	13 *	427309B	19 *	427315B
8	427304B	14	427310B	20	427316B
9 *	427305B	15 *	427311B		

* dans la limite des stocks disponibles

ATTACHEMENT | PINCES TARAUDAGE - ERXM 32 | ER 32 | ERX MJT 32

PRÉCISION 0,015

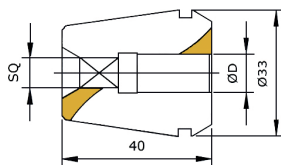

M	Ø D	SQ	Code	M	Ø D	SQ	Code
4	4,5	3,4	423760	12	9,0	7,0	423766
	5,0	4,0	423761	10	10,0	8,0	423767
	5,5	4,3	423762	14	11,0	9,0	423768
5-6	6,0	4,9	423763	16	12,0	9,0	423769
10x100	7,0	5,5	423764	18	14,0	11,0	423770
8	8,0	6,2	423765	20	16,0	12,0	423774



PINCES ER32 COMPENSATION

M	Ø D	Code
4	4,5	423740
5-6	6	423741
10x100	7	423742
8	8	423743
12	9	423744
10	10	423745
14	11	423746

PINCES ER32 JET POUR ALÉSOIR

Ø D	Code
4	800124
5	800125
6	800126
7	800127
8	800128
9	800129
10	800130
11	800131
12	800132
13	800133
14	800134

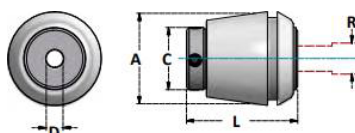

Articolo	R	C	A	L	D (mm)
ERC16PA	0,5	11	16	29	2 ÷ 7
ERC20PA	0,5	14	20	32	3 ÷ 8
ERC25PA	0,5	18,5	25	35	3 ÷ 10
ERC32PA	0,5	24	32	44	4 ÷ 14
ERC40PA	0,5	30	40	56	5 ÷ 16

PINCES ER32 ÉTANCHE 4 TROUS ARROSEMENT FACE

Code	
4,5	423926
6	423927
7	423928
8	423929
9	423930
10	423931
11	423932
12	423933
14	423934
16	423935



MANDRIN HYDRAULIQUE EXTRA COURT ET ACCESSOIRES

MANDRIN HYDRAULIQUE SK40 | BT40

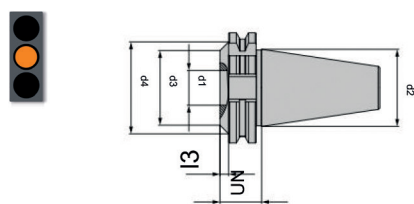

Référence	Code	d1	I3	A	Prix € net HT
SK 40 00 20 750 HDF	087663	20	5.4	24.5	290,00
BT 40 00 20 754 HDF	087664	20	5.5	32.5	290,00

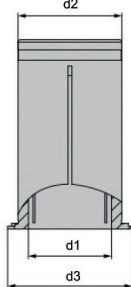

MANCHON DE RÉDUCTION

Référence D20	Code	Référence D32	Code	d1	I3	Prix D20 € net HT	Prix D32 € net HT
HDF20-03-IC	087665	-	-	3	4	119,56	-
HDF20-04-IC	087666	-	-	4	4	119,56	-
HDF20-05-IC	087667	-	-	5	4	119,56	-
HDF20-06-IC	087668	HDF32-06-IC	087674	6	4	93,93	119,56
HDF20-08-IC	087669	HDF32-08-IC	087675	8	4	93,93	119,56
HDF20-10-IC	087670	HDF32-10-IC	087676	10	4	93,93	119,56
HDF20-12-IC	087671	HDF32-12-IC	087677	12	4	93,93	119,56
HDF20-14-IC	087672	HDF32-14-IC	087678	14	4	93,93	119,56
HDF20-16-IC	087673	HDF32-16-IC	087679	16	4	93,93	119,56
-	-	HDF32-18-IC	087680	18	4	-	119,56
-	-	HDF32-20-IC	087681	20	4	-	119,56
-	-	HDF32-25-IC	087682	25	4	-	119,56

- Concentricité maximale
- Effet d'amortissement des vibrations
- Rigidité radiale élevée
- Serrage sans dispositifs supplémentaires
- Temps de réglage extrêmement rapide
- Plage flexible de 3 à 32 mm grâce à l'utilisation de douilles de réduction
- Force de serrage continue même à des vitesses élevées
- Sécurité de processus optimale
- Durée de vie maximale
- Compatible MQL
- Facilité d'entretien
- Gamme d'accessoires parfaitement adaptée
- Possibilité de serrage direct des queues lisses DIN6535HA, queues Weldon DIN6535HB et queues avec porte-outil WhistleNotch DIN6535HE (uniquement avec douille de réduction)

ADAPTATEUR CARBURE MONOBLOC



	Référence	d1	I3	Prix € net HT
M6	20 06 606/10 ZYL	6	20	303,64
	20 06 606/12 ZYL	6	20	341,48
	40 06 606/10 ZYL	6	40	325,59
	40 06 606/12 ZYL	6	40	364,82
	60 06 606/10 ZYL	6	60	353,09
	60 06 606/12 ZYL	6	60	403,93
	80 06 606/10 ZYL	6	80	389,42
	80 06 606/12 ZYL	6	80	427,26
100 06 606/12 ZYL	6	100	464,86	
M8	40 08 606	8	40	354,60
	60 08 606	8	60	390,81
	80 08 606	8	80	421,33
	100 08 606	8	100	453,38
	120 08 606	8	120	483,78
M10	60 10 606	10	60	448,96
	80 10 606	10	80	501,31
	100 10 606	10	100	550,64
	120 10 606	10	120	618,88
	140 10 606	10	140	690,16
M12	80 12 606	12	80	534,74
	100 12 606	12	100	655,34
	120 12 606	12	120	773,03
	140 12 606	12	140	892,12
M16	160 12 606	12	160	1 012,72
	100 16 606/32	16	100	1 217,09
	150 16 606/32	16	150	1 475,89
	200 16 606/32	16	200	1 780,19
	250 16 606/32	16	250	2 136,84
	300 16 606/32	16	300	2 444,22

ADAPTATEUR ANTIVIBRATION DENSE

	Référence	d1	I3	Prix € net HT
M8	40 08 601	8	40	370,75
	60 08 601	8	60	396,71
	80 08 601	8	80	422,96
	100 08 601	8	100	461,64
	120 08 601	8	120	493,22
	150 08 601	8	150	542,69
M10	60 10 601	10	60	453,20
	80 10 601	10	80	503,76
	100 10 601	10	100	565,24
	120 10 601	10	120	617,14
	140 10 601	10	140	694,85
M12	50 12 601	12	50	497,65
	75 12 601	12	75	568,42
	100 12 601	12	100	686,08
	125 12 601	12	125	831,96
	150 12 601	12	150	956,05
	175 12 601	12	175	1 044,69
M16	100 16 601/32	16	100	1 226,41
	150 16 601/32	16	150	1 484,37
	200 16 601/32	16	200	1 899,66
	250 16 601/32	16	250	2 261,98
	300 16 601/32	16	300	2 486,72

ATTACHEMENT | MANDRIN PORTE PINCES ER



EQUILIBRE 15 000 TRS/MN G2,5

- ER32
- GRANDE PRÉCISION $\leq 0,003$
- ARROSAGE CENTRAL

	L	Code	Prix promo € net HT
DIN 40	70	840054	33,49
BT 40	70	840353	33,49



EQUILIBRE 25 000 TRS/MN G2,5

- ER32
- GRANDE PRÉCISION $\leq 0,003$
- ARROSAGE CENTRAL

	L	Code	Prix promo € net HT
DIN 40	70	770060	74,64
BT 40	70	770065	73,07



EQUILIBRE 15 000 TRS/MN G2,5

- ER25
- GRANDE PRÉCISION $\leq 0,003$
- ARROSAGE CENTRAL

	L	Code	Prix promo € net HT
DIN 40	70	427235Z	30,00
BT 40	70	427236Z	30,00

EQUILIBRE 20 000 TRS/MN G2,5

- ER32
- GRANDE PRÉCISION $\leq 0,003$
- ARROSAGE CENTRAL

	L	Code	Prix promo € net HT
DIN 40	70	427217Z	39,37
BT 40	70	427216Z	39,37



EQUILIBRE 15 000 TRS/MN G2,5

- ER16
- GRANDE PRÉCISION $\leq 0,003$
- ARROSAGE CENTRAL

	L	Code	Prix promo € net HT
DIN 40	70	427482Z	30,00
BT 40	70	427483Z	30,00

EQUILIBRE 15 000 TRS/MN G2,5

- ER32
- GRANDE PRÉCISION $\leq 0,003$
- ARROSAGE CENTRAL

	L	Code	Prix promo € net HT
DIN 40	70	427222Z	30,00
BT 40	70	427221Z	30,00

Le saviez-vous ?

Disponibles jusqu'en
longueur 200

ATTACHEMENT | PORTE PINCES QUEUE CYLINDRIQUE

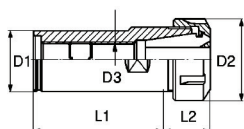

TYPE	CAP	D1	D2	D3	L1	L2	Code	Prix promo € net HT
32 NC ER32	2 20	32	50	22 x 1,5	80	33	427230B	42,40
40 NC ER32	2 20	40	50	22 x 1,5	80	33	427231B	37,55

ATTACHEMENT | DOUILLE DE RÉDUCTION CYLINDRIQUE



D	L	D1	Code
		6	427570B
		8	427571B
		10	427572B
32	90	12	427573B
		16	427574B
		20	427575B
		25	427576B

34
€ HT

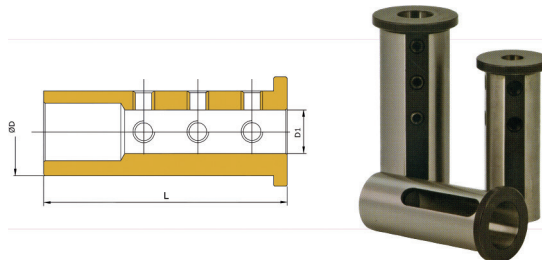

D	L	D1	Code
		8	427930B
		10	427931B
		12	427932B
40	80	16	427933B
		20	427934B
		25	427935B
		32	427936B

34
€ HT

ATTACHEMENT | RALLONGE PORTE PINCES | ER - ECROU MINI



TYPE	CAP	D	D1	L	Code	Prix promo € net HT	TYPE	CAP	D	D1	L	Code	Prix promo € net HT		
ER8	1	5	12	12	100	870001	26,50	ER16	1	10	22	10	80	870006	26,50
ER11	1	7	16	8	55	870002	24,73	ER16	1	10	22	12	80	870007	26,50
ER11	1	7	16	10	60	870003	26,50	ER16	1	10	22	16	80	870008	28,27
ER11	1	7	16	12	70	870004	26,50	ER16	1	10	22	16	130	870009	29,15
ER11	1	7	16	16	100	870005	28,27	ER16	1	10	22	20	100	870010	28,27
								ER16	1	10	22	20	160	870011	33,57

ATTACHEMENT | MANDRINS À PINCES - PSC6



Mandrin à pinces - PSC6

Désignation	L1	Equilibrage	Code	Prix promo € HT
MANDRIN A PINCE PSC6 ER16	100	G2,5 25000	427013	184,96
MANDRIN A PINCE PSC6 ER20	60	G2,5 25000	427014	174,46
MANDRIN A PINCE PSC6 ER20	100	G2,5 25000	427015	183,96
MANDRIN A PINCE PSC6 ER25	60	G2,5 25000	427016	174,46
MANDRIN A PINCE PSC6 ER25	100	G2,5 25000	427017	184,96
MANDRIN A PINCE PSC6 ER32	70	G2,5 25000	427018	174,46
MANDRIN A PINCE PSC6 ER32	100	G2,5 25000	427019	184,96
MANDRIN A PINCE PSC6 ER40	65	G2,5 25000	427020	178,66

ATTACHEMENT | MANDRIN PORTE-FRAISE | TROU LISSE

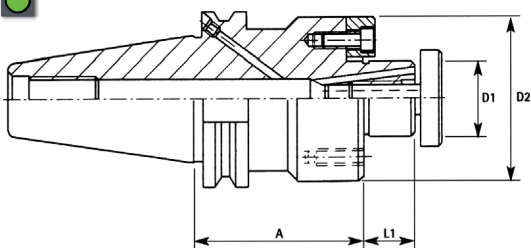

ARROSAGE CENTRE
| AUTRE LONGUEUR SUR DEMANDE |

	A	D1	D2	L1	Code	Prix promo € net HT
DIN 40	45	16	38	17	840118	53,03
	45	22	48	19	840119	53,03
	50	27	58	21	840120	58,92
	55	32	66	24	840121	61,67
	55	40	80	27	840122	67,50
BT 40	45	16	38	17	840417	58,92
	45	22	48	19	840418	58,92
	45	27	58	21	840419	58,92
	50	32	78	24	840420	61,67
	55	40	88	27	840421	67,50

ÉQUILIBRAGE 15 000 TRS/MN G6,3

• GRANDE PRÉCISION ≤0,003

ATTACHEMENT | MANDRIN FORT SERRAGE

PORTE-PINCES BT40

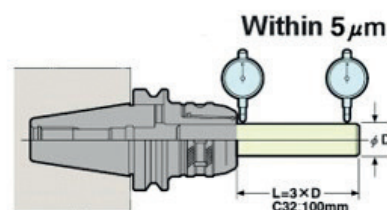

Désignation	Référence fournisseur	Code	Prix promo € net HT
PORTE-PINCE BT40	BT40-C20-90	090993	516,75
PORTE-PINCE BT40	BT40-C32-105	090994	536,25

ATTACHEMENT | CLE DYNAMOMETRIQUE



CLÉ DYNAMOMÉTRIQUE STD

CLÉ DYNAMOMÉTRIQUE MINI

Type	Article	Code	Prix promo € net HT	Type	Article	Code	Prix promo € net HT
CLE DYNAMOMETRIQUE STD ER16	WR.DIN.16	427532Z	98,93	CLE DYNAMOMETRIQUE ER8 MINI	WR.DIN.8.MINI	427537Z	40,50
CLE DYNAMOMETRIQUE STD ER20	WR.DIN.20	427533Z	109,53	CLE DYNAMOMETRIQUE ER11 MINI	WR.DIN.11.MINI	427538Z	40,50
CLE DYNAMOMETRIQUE STD ER25	WR.DIN.25	427534Z	109,53	CLE DYNAMOMETRIQUE ER16 MINI	WR.DIN.16.MINI	427539Z	40,50
CLE DYNAMOMETRIQUE STD ER32	WR.DIN.32	427535Z	109,53	CLE DYNAMOMETRIQUE ER20 MINI	WR.DIN.20.MINI	427541Z	42,00
CLE DYNAMOMETRIQUE STD ER40	WR.DIN.40	427536Z	81,67	CLE DYNAMOMETRIQUE ER25 MINI	WR.DIN.25.MINI	427542Z	42,00



Type	Diamètre	Article	Code	Prix promo € net HT
CLE DYNAMOMETRIQUE DMK 100	20 - 100	2641232	418006	261,91
CLE DYNAMOMETRIQUE DMUK 100	20 - 100	2641305	418001	361,89

ATTACHEMENT | MANDRIN PORTE-FRAISE - PSC6



PSC6

Désignation	Ø	L1	Equilibrage	Code	Prix promo € net HT
MANDRIN PORTE FRAISE PSC6	16	35	G2,5 25000	427021	155,47
MANDRIN PORTE FRAISE PSC6	22	40	G2,5 25000	427022	155,47
MANDRIN PORTE FRAISE PSC6	27	40	G2,5 25000	427023	155,47
MANDRIN PORTE FRAISE PSC6	32	40	G2,5 25000	427024	155,47
MANDRIN PORTE FRAISE PSC6	40	45	G2,5 25000	427025	159,00

ATTACHEMENT | MANDRIN PORTE-FRAISE À QUEUE FILETÉE



Longueur 25



Autres longueurs

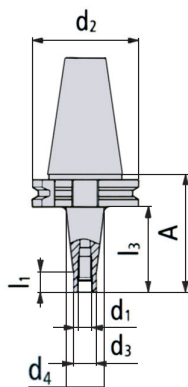

Queue conique

Queue conique				HSK63A		DIN40		BT40	
D1	L3	D3	D4	Code	Prix promo € net HT	Code	Prix promo € net HT	Code	Prix promo € net HT
M8	25	13,8	15	087383	185,58	087338	103,92	087364	122,95
M8	50	13,8	23	087330	197,16	087310	111,47	087320	111,47
M8	75	13,8	25	087331	213,47	087342	119,43	087365	119,43
M8	100	13,8	30	087384	227,37	087349	142,60	087366	128,79
M10	25	18	23	087385	185,58	087339	103,92	087367	103,92
M10	50	18	25	087332	197,16	087311	111,47	087321	122,77
M10	75	18	30	087333	213,47	087343	119,43	087368	119,43
M10	100	18	35	087386	227,37	087350	142,60	087369	142,60
M12	25	21	24	087389	185,58	087340	122,97	087370	103,92
M12	50	21	30	087334	197,16	087312	111,47	087322	111,47
M12	75	21	35	087335	213,47	087345	119,43	087371	119,43
M12	100	21	38	087390	227,37	087352	142,60	087372	128,79
M16	25	29	29	087393	185,58	087341	122,97	087373	112,18
M16	50	29	34	087336	197,16	087313	111,47	087323	122,77
M16	75	29	35	087337	213,47	087347	119,43	087374	135,20
M16	100	29	40	087394	227,37	087354	142,60	087375	128,79

Queue cylindrique

Queue cylindrique				HSK63A		DIN40		BT40	
D1	L3	D3	D4	Code	Prix promo € net HT	Code	Prix promo € net HT	Code	Prix promo € net HT
M8	50	13,8	13,8	087399	197,16	087314	135,22	087324	135,22
M10	50	18	18	087400	197,16	087315	135,22	087325	135,22
M10	75	18	18	087401	212,27	087344	127,58	087377	141,65
M10	100	18	18	087402	211,19	087351	148,09	087380	148,09
M12	50	21	21	087403	197,16	087316	135,22	087326	135,22
M12	75	21	21	087404	212,27	087346	127,58	087378	141,65
M12	100	21	21	087405	227,37	087353	148,09	087381	148,09
M16	50	29	29	087406	197,16	087317	135,22	087327	135,22
M16	75	29	29	087407	223,85	087348	141,65	087379	141,65
M16	100	29	29	087408	227,37	087355	135,74	087382	148,09

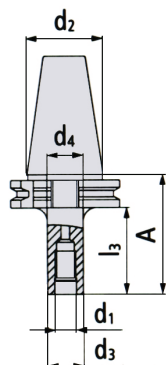

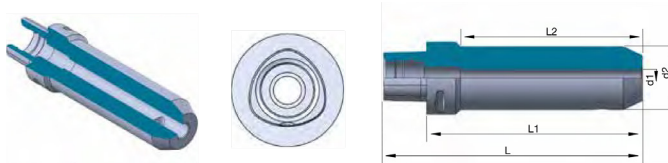

Mandrin Weldon - PSC6



Désignation	Ø	L1	Equilibrage	Code	Prix promo € HT
MANDRIN WELDON PSC6 D6	6	55	G2,5 25000	427026	134,54
MANDRIN WELDON PSC6 D8	8	55	G2,5 25000	427027	134,54
MANDRIN WELDON PSC6 D10	10	60	G2,5 25000	427028	134,54
MANDRIN WELDON PSC6 D12	12	60	G2,5 25000	427029	134,54
MANDRIN WELDON PSC6 D14	14	60	G2,5 25000	427030	134,54
MANDRIN WELDON PSC6 D16	16	65	G2,5 25000	427031	134,54
MANDRIN WELDON PSC6 D18	18	65	G2,5 25000	427032	134,54
MANDRIN WELDON PSC6 D20	20	65	G2,5 25000	427033	134,54
MANDRIN WELDON PSC6 D25	25	80	G2,5 25000	427034	138,62
MANDRIN WELDON PSC6 D32	32	90	G2,5 25000	427035	157,78
MANDRIN WELDON PSC6 D40	40	100	G2,5 25000	427036	161,45

ATTACHEMENT | MANDRIN WELDON ARROSAGE CENTRE ET FACE

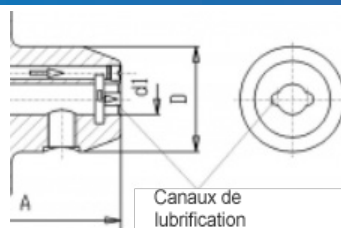
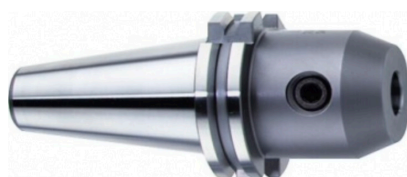

Désignation	Référence fournisseur	Code	Prix promo € HT
MAND WELD DIN40 D6 10000TR/G6,3	ARROSAGE FACE +AD+B SK40	446360	60,06
MAND WELD DIN40 D8 10000TR/G6,3	ARROSAGE FACE +AD+B SK40	446362	60,06
MAND WELD DIN40 D10 10000TR/G6,3	ARROSAGE FACE +AD+B SK40	446364	60,06
MAND WELD DIN40 D12 10000TR/G6,3	ARROSAGE FACE +AD+B SK40	446366	60,06
MAND WELD DIN40 D14 10000TR/G6,3	ARROSAGE FACE +AD+B SK40	446368	60,06
MAND WELD DIN40 D16 10000TR/G6,3	ARROSAGE FACE +AD+B SK40	446370	60,06
MAND WELD DIN40 D18 10000TR/G6,3	ARROSAGE FACE +AD+B SK40	446372	60,06
MAND WELD DIN40 D20 10000TR/G6,3	ARROSAGE FACE +AD+B SK40	446374	60,06
MAND WELD DIN40 D25 10000TR/G6,3	ARROSAGE FACE +AD+B SK40	446376	60,06

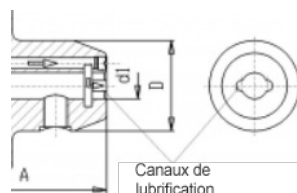

Désignation	Référence fournisseur	Code	Prix promo € HT
MAND WELD BT40 D6 10000TR/G6,3	ARROSAGE FACE +AD+B BT40	446390	61,03
MAND WELD BT40 D8 10000TR/G6,3	ARROSAGE FACE +AD+B BT40	446392	61,03
MAND WELD BT40 D10 10000TR/G6,3	ARROSAGE FACE +AD+B BT40	446394	61,03
MAND WELD BT40 D12 10000TR/G6,3	ARROSAGE FACE +AD+B BT40	446396	61,03
MAND WELD BT40 D14 10000TR/G6,3	ARROSAGE FACE +AD+B BT40	446398	61,03
MAND WELD BT40 D16 10000TR/G6,3	ARROSAGE FACE +AD+B BT40	446400	72,05
MAND WELD BT40 D18 10000TR/G6,3	ARROSAGE FACE +AD+B BT40	446402	72,05
MAND WELD BT40 D20 10000TR/G6,3	ARROSAGE FACE +AD+B BT40	446404	72,05
MAND WELD BT40 D25 10000TR/G6,3	ARROSAGE FACE +AD+B BT40	446408	72,05



pagnoni
tools

serinex
CNC TOOLHOLDER SYSTEM



	Désignation	Equilibrage	Code	Prix promo € HT	Code	Prix promo € HT
DIN 40	MAND WELDON DIN40 D6 L50 P	G2.5 15000 tr/mn			446306Z	30,77
	MAND WELDON DIN40 D8 L50 P	G2.5 15000 tr/mn	840005	31,15	446308Z	30,77
	MAND WELDON DIN40 D10 L50 P	G2.5 15000 tr/mn	840006	31,15	446310Z	30,77
	MAND WELDON DIN40 D12 L50 P	G2.5 15000 tr/mn	840007	31,15	446312Z	30,77
	MAND WELDON DIN40 D14 L50 P	G2.5 15000 tr/mn	840008	31,15	446314Z	30,77
	MAND WELDON DIN40 D16 L63 P	G2.5 15000 tr/mn	840009	31,15	446316Z	30,77
	MAND WELDON DIN40 D18 L63 P	G2.5 15000 tr/mn	840010	31,15	446318Z	30,77
	MAND WELDON DIN40 D20 L63 P	G2.5 15000 tr/mn	840011	31,15	446320Z	30,77
	MAND WELDON DIN40 D25 L100 P	G2.5 15000 tr/mn			446325Z	30,77
	MAND WELDON DIN40 D32 L100 P	G2.5 15000 tr/mn			446332Z	30,77
BT 40	MAND WELDON BT40 D6 L50 P	G2.5 15000 tr/mn			446106Z	30,77
	MAND WELDON BT40 D8 L50 P	G2.5 15000 tr/mn	840304	31,15	446108Z	30,77
	MAND WELDON BT40 D10 L65 P	G2.5 15000 tr/mn	840305	31,15	446110Z	30,77
	MAND WELDON BT40 D12 L65 P	G2.5 15000 tr/mn	840306	31,15	446112Z	30,77
	MAND WELDON BT40 D14 L63 P	G2.5 15000 tr/mn	840307	31,15	446114Z	30,77
	MAND WELDON BT40 D16 L63 P	G2.5 15000 tr/mn	840308	31,15	446116Z	30,77
	MAND WELDON BT40 D18 L70 P	G2.5 15000 tr/mn	840309	31,15	446118Z	30,77
	MAND WELDON BT40 D20 L70 P	G2.5 15000 tr/mn	840310	31,15	446120Z	30,77
	MAND WELDON BT40 D25 L100 P	G2.5 15000 tr/mn			446125Z	30,77
	MAND WELDON BT40 D32 L100 P	G2.5 15000 tr/mn			446132Z	30,77

| AUTRE LONGUEUR SUR DEMANDE |



Désignation	Référence fournisseur	Code	Prix promo € HT
ID WELDON ISO40 DIN69871 H50 D.6 AD	AFB140WLK06	840816	48,88
ID WELDON ISO40 DIN69871 H50 D.8 AD	AFB140WLK08	840817	46,52
ID WELDON ISO40 DIN69871 H50 D.10 AD	AFB140WLK10	840818	46,52
ID WELDON ISO40 DIN69871 H50 D.12 AD	AFB140WLK12	840819	46,52
ID WELDON ISO40 DIN69871 H50 D.14 AD	AFB140WLK14	840820	46,52
ID WELDON ISO40 DIN69871 H63 D.16 AD	AFB140WLK16	840821	46,52
ID WELDON ISO40 DIN69871 H63 D.18 AD	AFB140WLK18	840822	46,52
ID WELDON ISO40 DIN69871 H63 D.20 AD	AFB140WLK20	840823	46,52
ID WELDON ISO40 DIN69871 H100 D.25 AD	AFB140WLK25	840824	54,42
ID WELDON ISO40 DIN69871 H100 D.32 AD	AFB140WLK32	840825	64,11



Désignation	Référence fournisseur	Code	Prix promo € HT
MAND WELDON BT40 MAS403 H50 D.06 AD	AFB340WLK06	840826	48,88
MAND WELDON BT40 MAS403 H50 D.08 AD	AFB340WLK08	840827	46,52
MAND WELDON BT40 MAS403 H63 D.10 AD	AFB340WLK10	840828	46,52
MAND WELDON BT40 MAS403 H63 D.12 AD	AFB340WLK12	840829	46,52
MAND WELDON BT40 MAS403 H63 D.14 AD	AFB340WLK14	840830	46,52
MAND WELDON BT40 MAS403 H63 D.16 AD	AFB340WLK16	840831	46,52
MAND WELDON BT40 MAS403 H63 D.18 AD	AFB340WLK18	840832	46,52
MAND WELDON BT40 MAS403 H63 D.20 AD	AFB340WLK20	840833	46,52
MAND WELDON BT40 MAS403 H90 D.25 AD	AFB340WLK25	840834	54,42
MAND WELDON BT40 MAS403 H100 D.32 AD	AFB340WLK32	840835	64,11
MAND WELDON BT40 MAS403 H107 D.40 AD	AFB340WLK40	840836	76,08

ATTACHEMENT | MANDRINS DE FRETTAGE



	D	L	Code	Prix promo € net HT
BT 40	3	90	770036	144,62
	4	90	770037	144,62
	6	90	770005	111,54
	8	90	770007	111,54
	10	90	770009	111,54
	12	90	770011	111,54
	16	90	770015	111,54
	20	90	770019	111,54
DIN 40	4	80	740023	131,54
	5	80	740024	131,54
	6	80	740006	105,38
	8	80	740008	105,38
	10	80	740010	105,38
	12	80	740012	105,38
	16	80	740016	105,38
	20	80	730017	119,23
HSK63A	8	80	730018	119,23
	10	85	730019	119,23
	16	95	730010	119,23
	20	100	730012	119,23

EQUILIBRE 25 000 TRS/MN G2,5

• GRANDE PRÉCISION ≤0,003

	D	L	Code	Prix promo € net HT
DIN 40	6	80	740006W	66,15
	8	80	740008W	66,15
	10	80	740010W	66,15
	12	80	740012W	66,15
	14	80	740014W	66,15
	16	80	740016W	66,15
	18	80	740018W	66,15
	20	80	740020W	66,15
BT 40	6	90	770005W	66,15
	8	90	770007W	66,15
	10	90	770009W	66,15
	12	90	770011W	66,15
	14	90	770013W	66,15
	16	90	770015W	66,15
	18	90	770017W	66,15
	20	90	770019W	66,15

EQUILIBRE 25 000 TRS/MN G2,5

• GRANDE PRÉCISION ≤0,003

ATTACHEMENT | MANDRINS DE FRETTAGE

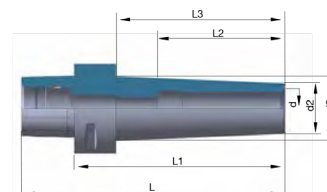

PSC6

Désignation	Ø	L1	Equilibrage	Code	Prix promo € HT
MANDRIN FRETTAGE PSC6	8	80	G2,5 25000	427004	146,77
MANDRIN FRETTAGE PSC6	10	80	G2,5 25000	427005	146,77
MANDRIN FRETTAGE PSC6	12	80	G2,5 25000	427006	146,77
MANDRIN FRETTAGE PSC6	14	85	G2,5 25000	427007	146,77
MANDRIN FRETTAGE PSC6	16	85	G2,5 25000	427008	146,77
MANDRIN FRETTAGE PSC6	18	85	G2,5 25000	427009	146,77
MANDRIN FRETTAGE PSC6	20	85	G2,5 25000	427010	146,77
MANDRIN FRETTAGE PSC6	25	90	G2,5 25000	427011	146,77
MANDRIN FRETTAGE PSC6	32	95	G2,5 25000	427012	146,77

Diamètres 3, 4, 5, 6 disponibles sur demande

ATTACHEMENT | MANDRINS DE FRETTAGE FIN

serinex
componenti per macchine utensili



D	A	D1	D	L	Désignation	Référence	Code	Prix promo € HT
6	90	12	17	61	SLIM TYPE HSK63A H90 CL6	HSK.A.63.90.CL6.SL	740165	94,58
8	90	14	19	64	SLIM TYPE HSK63A H90 CL8	HSK.A.63.90.CL8.SL	740166	81,54
10	90	16	21	64	SLIM TYPE HSK63A H90 CL10	HSK.A.63.90.CL10.SL	740167	81,54
12	90	18	23	64	SLIM TYPE HSK63A H90 CL12	HSK.A.63.90.CL12.SL	740168	81,54
14	90	18	23	64	SLIM TYPE HSK63A H90 CL14	HSK.A.63.90.CL14.SL	740169	81,54
16	95	24	29	64	SLIM TYPE HSK63A H95 CL16	HSK.A.63.95.CL16.SL	740170	81,54
20	100	32	39	74	SLIM TYPE HSK63A H100 CL20	HSK.A.63.100.CL20.SL	740185	81,54

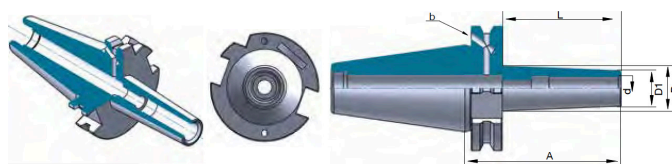

D	A	D1	D	L	Désignation	Référence	Code	Prix promo € HT
6	80	12	17	61	SLIM TYPE TCB40 H80 CL6	SKB.40.80.CL6.SL	740171	70,12
8	80	14	19	61	SLIM TYPE TCB40 H80 CL8	SKB.40.80.CL8.SL	740172	70,12
10	80	16	21	61	SLIM TYPE TCB40 H80 CL10	SKB.40.80.CL10.SL	740173	70,12
12	80	18	23	61	SLIM TYPE TCB40 H80 CL12	SKB.40.80.CL12.SL	740174	70,12
14	80	22	25	61	SLIM TYPE TCB40 H80 CL14	SKB.40.80.CL14.SL	740175	70,12
16	80	24	29	61	SLIM TYPE TCB40 H80 CL16	SKB.40.80.CL16.SL	740176	70,12
20	80	32	39	61	SLIM TYPE TCB40 H80 CL20	SKB.40.80.CL20.SL	740177	70,12

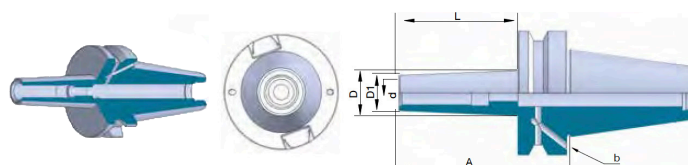

D	A	D1	D	L	Désignation	Référence	Code	Prix promo € HT
6	90	12	17	63	SLIM TYPE BTB40 H90 CL6	BTB.40.90.CL6.SL	740178	70,12
8	90	14	19	63	SLIM TYPE BTB40 H90 CL8	BTB.40.90.CL8.SL	740179	70,12
10	90	16	21	63	SLIM TYPE BTB40 H90 CL10	BTB.40.90.CL10.SL	740180	70,12
12	90	18	23	63	SLIM TYPE BTB40 H90 CL12	BTB.40.90.CL12.SL	740181	70,12
14	90	22	25	63	SLIM TYPE BTB40 H90 CL14	BTB.40.90.CL14.SL	740182	70,12
16	90	24	29	63	SLIM TYPE BTB40 H90 CL16	BTB.40.90.CL16.SL	740183	70,12
20	90	28	33	63	SLIM TYPE BTB40 H90 CL20	BTB.40.90.CL20.SL	740184	70,12

ATTACHEMENT | DEMONTE CONE ORIENTABLE



CONES	Code	Prix promo € net HT
CONE 40 HSK63A CAPTO C6	840800	96,36
CONE 50 HSK100 CAPTO C10	840801	154,18

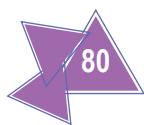



Frettage à froid TRIBOS

Désignation	Code	€ tarif ht
TRIBOS-Mini SVL-12 Ø3x100 RALLONGE ETANCHE	438080	199,00
TRIBOS-Mini SVL-12 Ø4x100 RALLONGE ETANCHE	438081	199,00
TRIBOS-Mini SVL-12 Ø5x100 RALLONGE ETANCHE	438082	199,00
TRIBOS-Mini SVL-12 Ø6x100 RALLONGE ETANCHE	438083	199,00
Dispositif d'assemblage TRIBOS-RM/-Mini SVP	438084	106,00
SVP-MINI DISPOSITIF DE FRETTAGE	438085	525,00



HSK-A 63



BT 40



SK 40

Porte-outils hydro

Désignation	Code	€ tarif ht
TENDO Silver HSK-A 63 Ø20x90	438086	210,00
TENDO Silver JIS-BT 40 Ø20x90	438087	203,00
TENDO Silver SK 40 Ø20x80.5	438088	203,00



BT 40



HSK-A 63



SK 40

Porte-outils hydro fin

Désignation	Code	€ tarif ht
TENDO Slim 4ax JIS-BT 40 Ø10x90	438099	310,00
TENDO Slim 4ax JIS-BT 40 Ø12x90	438100	311,33
TENDO Slim 4ax JIS-BT 40 Ø6x90	438113	310,00
TENDO Slim 4ax JIS-BT 40 Ø8x90	438114	310,00
TENDO Slim 4ax JIS-BT 40 Ø10x90	438115	310,00
TENDO Slim 4ax JIS-BT 40 Ø12x90	438116	310,00
TENDO Slim 4ax HSK-A63 Ø6x80	438103	330,00
TENDO Slim 4ax HSK-A63 Ø8x80	438104	330,00
TENDO Slim 4ax HSK-A63 Ø10x85	438105	330,00
TENDO Slim 4ax HSK-A63 Ø12x90	438106	330,00
TENDO Slim 4ax HSK-A63 Ø6x120	438107	375,00
TENDO Slim 4ax HSK-A63 Ø8x120	438108	375,00
TENDO Slim 4ax SK 40 Ø6x80	438109	310,00
TENDO Slim 4ax SK 40 Ø8x80	438110	310,00
TENDO Slim 4ax SK 40 Ø10x80	438111	310,00
TENDO Slim 4ax SK 40 Ø12x80	438112	310,00



Désignation	Code	€ tarif ht
GZB-S Ø 20/Ø 6/50,5 DOUILLE REDUCTION ETANCHE	438089	79,00
GZB-S Ø 20/Ø 8/50,5 DOUILLE REDUCTION ETANCHE	438090	79,00
GZB-S Ø 20/Ø 10/50,5 DOUILLE REDUCTION ETANCHE	438091	79,00
GZB-S Ø 20/Ø 12/50,5 DOUILLE REDUCTION ETANCHE	438092	79,00
GZB-S Ø 20/Ø 16/50,5 DOUILLE REDUCTION ETANCHE	438093	79,00
GZB-S Ø 20/Ø 6/50,5 DOUILLE REDUCTION FENDUE	438094	104,00
GZB-S Ø 20/Ø 8/50,5 DOUILLE REDUCTION FENDUE	438095	104,00
GZB-S Ø 20/Ø 10/50,5 DOUILLE REDUCTION FENDUE	438096	104,00
GZB-S Ø 20/Ø 12/50,5 DOUILLE REDUCTION FENDUE	438097	104,00
GZB-S Ø 20/Ø 16/50,5 DOUILLE REDUCTION FENDUE	438098	104,00

MORS DOUX RAPPORTÉS DROITS EN ACIER

Pas de 1,5 - 60°



Désignation	Code	€ tarif ht	Pour mandrins
Mors doux KM-WB 61	438117	63,00	B106 - B206 Ø169
Mors doux KM-WB 84	438118	61,70	B108 - B208 Ø210
Mors doux KM-WB 102	438119	64,70	B110 - B210 Ø254



Désignation	Référence	€ tarif ht
Mors doux pour semelle à changement rapide Ø160	153100	39,50
Mors doux pour semelle à changement rapide Ø200	153101	47,30
Mors doux pour semelle à changement rapide Ø250	153102	69,10
Mors doux pour semelle à changement rapide Ø315	153103	98,20



ATTACHEMENTS COOLCAP

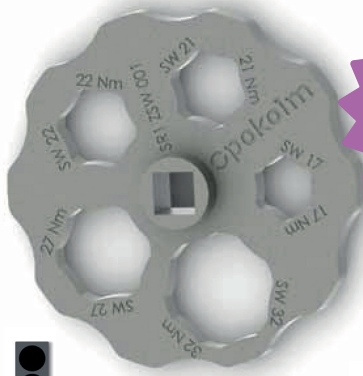

Prix sur demande

Clé universelle pour tous les écrous CoolCap - à commander



SK 40



Référence	d1	I3	A	Code	Prix Frettage € net HT	Code	Prix Weldon € net HT
50 04 750 SR1	4	50	69,1	087610	241,75		-
50 06 750 SR1	6	50	69,1	087611	241,75		-
50 08 750 SR1	8	50	69,1	087612	241,75		-
50 10 750 SR1 / W	10	50	69,1	087613	241,75	087617	241,75
50 12 750 SR1 / W	12	60	79,1	087614	241,75	087618	241,75
60 16 750 SR1 / W	16	60	79,1	087615	241,75	087619	241,75
60 20 750 SR1 / W	20	60	79,1	087616	241,75	087620	241,75

BT 40 MAS BT



Référence	d1	I3	A	Code	Prix Frettage € net HT	Code	Prix Weldon € net HT
50 06 754 SR1	6	50	77	087621	241,75		-
50 08 754 SR1	8	50	77	087622	241,75		-
50 10 754 SR1 / W	10	50	77	087623	241,75	087626	241,75
50 12 754 SR1 / W	12	60	87	087624	241,75	087627	241,75
60 16 754 SR1 / W	16	60	87	087625	241,75	087628	245,63

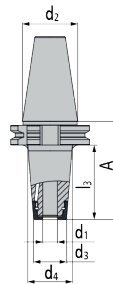

HSK 63 FORM A

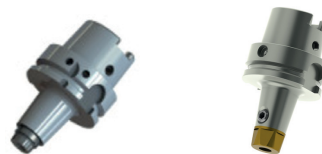

Référence	d1	I3	A	Code	Prix Frettage € net HT	Code	Prix Weldon € net HT
50 10 A63 SR1 / W	10	50	76	087632	271,63	087636	271,63
60 12 A63 SR1 / W	12	60	86	087633	271,63	087637	271,63
60 16 A63 SR1 / W	16	60	86	087634	271,63	087638	271,63
60 20 A63 SR1 / W	20	60	86	087635	271,63	087639	271,63

Diamètre coiffe	Prix Air € net HT	Prix Eau € net HT
Coiffe Ø4	32,26	46,32
Coiffe Ø6	32,26	32,26
Coiffe Ø8	32,26	32,26
Coiffe Ø10	32,26	32,26
Coiffe Ø12	32,26	32,26
Coiffe Ø16	54,29	32,26
Coiffe Ø20	54,29	54,29

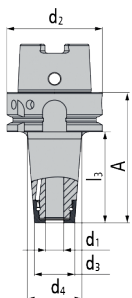

Coiffe offerte
Offre n° 2026-1005004

MAINTENANCE | FILTRES POUR MACHINES - OUTILS



1 rouleau de Velum =
2 ans de protection totale

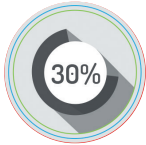

Réduit les coûts
d'entretien de 30%



Empêche la propagation
de particules nocives



Pas de temps d'arrêt
de la machine



Protégez votre entreprise
avec 20 centimes par jour



Remplacement
en 5 secondes



Contrôle visuel permettant
de savoir quand le filtre
doit être changé



Pas d'ouverture
de l'appareil électrique

FILTRE VELUM

INDIQUÉ POUR LA PROTECTION DE CADRES ÉLECTRIQUES



CHAQUE ROULEAU EST COMPOSÉ DE 110 FEUILLES

FILTRE VELUM	Codes	Code	Prix unitaire € net HT
VELUM 200 FILTRE 200 MM	VELFIL000200.01	438003	33,50
VELUM 300 FILTRE 300 MM	VELFIL000300.01	438000	59,00
VELUM 400 FILTRE 400 MM	VELFIL000400.01	438001	68,00
VELUM 500 FILTRE 500 MM	VELFIL000500.01	438002	77,00
VELUM 600 FILTRE 600 MM	VELFIL000600.01	438004	86,00

FILTRE VELUM AIR	Codes	Code	Prix unitaire € net HT
VELUM AIR 200 FILTRE 200 MM	VELAIRFIL200.01	438010	35,00
VELUM AIR 300 FILTRE 300 MM	VELAIRFIL300.01	438011	62,00
VELUM AIR 400 FILTRE 400 MM	VELAIRFIL400.01	438012	71,50
VELUM AIR 500 FILTRE 500 MM	VELAIRFIL500.01	438013	81,00
VELUM AIR 600 FILTRE 600 MM	VELAIRFIL600.01	438014	90,00

FILTRE VELUM AIR
POUR LA PROTECTION D'ÉCHANGEURS DE CHALEUR |
DE CLIMATISEURS | DE COMPRESSEURS



CHAQUE ROULEAU EST COMPOSÉ DE 60 FEUILLES

FILTRE VELUM MOTOR

POUR LA PROTECTION DE MOTEURS ÉLECTRIQUES

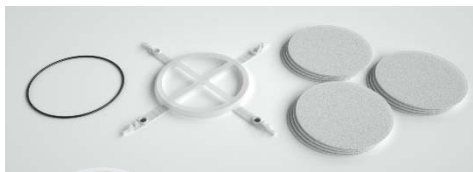

CHAQUE FILTRE CONTIENT :

- 1 SUPPORT EN PLASTIQUE COMPLET AVEC LES AIMANTS
- 1-O RING
- 12 FILTRES

FILTRE VELUM AIR	Codes	Code	Prix unitaire € net HT
VELUM MOTOR 100 FILTRE Ø 100MM	VELMOT000100.01	438020	38,00
VELUM MOTOR 120 FILTRE Ø 120MM	VELMOT000120.01	438021	40,00
VELUM MOTOR 150 FILTRE Ø 150MM	VELMOT000150.01	438022	46,00
VELUM MOTOR 175 FILTRE Ø 175MM	VELMOT000175.01	438023	50,00
VELUM MOTOR 200 FILTRE Ø200MM	VELMOT000200.01	438024	54,00
VELUM MOTOR 230 FILTRE Ø230MM	VELMOT000230.01	438025	62,00
VELUM MOTOR 260 FILTRE Ø260MM	VELMOT000260.01	438026	68,00
VELUM MOTOR 300 FILTRE Ø 300MM	VELMOT000300.01	438027	74,00



installation



replacement





SYSTÈME DE SERRAGE POINT ZÉRO CentroLite 68K I-Gripp b67

Pour platine entraxe
52x52

À partir de
593 €
HT

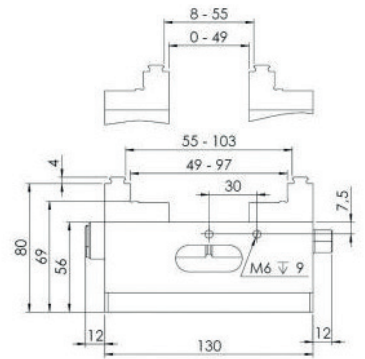
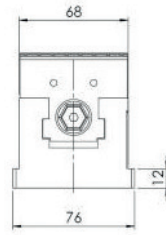
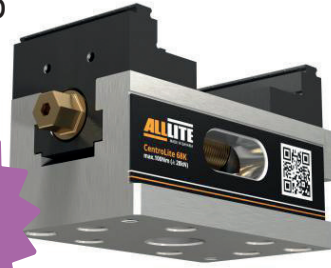

SYSTÈME DE BRIDAGE POINT ZÉRO CentroLite 68M

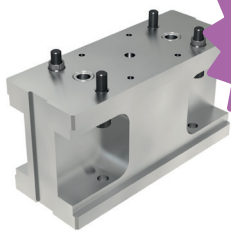

À partir de
529 €
HT

SYSTÈME DE SERRAGE POINT ZÉRO CentroLite 125M I-Gripp b124

Pour platine entraxe
96x96



À partir de
867 €
HT

SYSTÈME DE CHARGEMENTS MANUELS GFD mini 130-100-1 52/96



À partir de
1 140 €
HT



Retrouvez les
plans en scannant
le QR Code

ACCESSOIRES POUR SYSTÈME DE SERRAGE MANUEL STANDARD GFD-SP mini Ø20-h6



À partir de
40 €
HT



Désignation	Code	€ tarif ht
Étau 5 axes KSC-5X 125-320-142	438101	2 200,00
Mors réversibles grip SGWB-G3-B 125-57-33	438102 *	151,00

* A l'unité



PRISE PIÈCES | ÉTAUX DE PRÉCISION - ÉTAUX GAMMES CLG

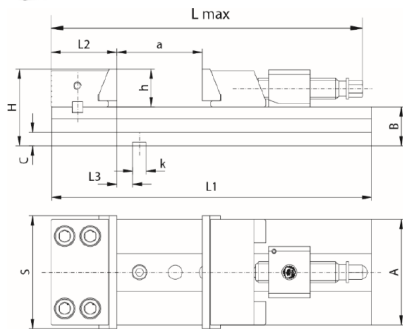
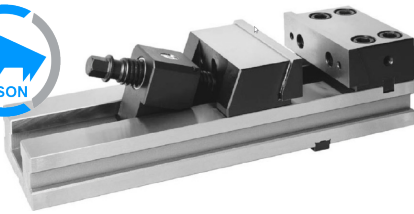

a	S	h	L1	Référence fournisseur	Code	Prix promo € net HT
165	100	30	320	326620010600	412048	876,00
165	125	40	335	326620030000	412049	1051,38
210	150	50	425	326620050300	412050	1322,77
260	150	50	475	326620060500	412051	1377,23
260	200	60	535	326620100500	412052	1991,08
310	200	60	585	326620110700	412053	2051,08
360	200	60	635	326620120900	412054	2253,23

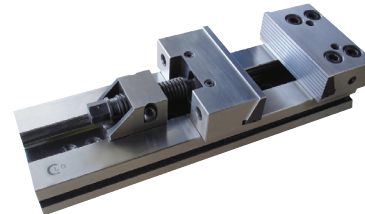

ETAUX CLG	Largeur	Hauteur semelle	Ouverture	Longueur semelle	Hauteur mors	Code	Prix promo € net HT
ETAUX CLG 100X150	100	35	150	320	30	415009	333,40
ETAUX CLG 125X150	125	40	150	345	40	415003	327,42
ETAUX CLG 150X200	150	50	200	420	50	415001	432,31
ETAUX CLG 150X300	150	50	300	520	50	415005	505,60
ETAUX CLG 150X400	150	50	400	620	50	415012	739,89
ETAUX CLG 200X300	200	70	300	595	65	415002	844,48
ETAUX CLG 200X400	200	70	400	695	65	415004	971,86



PRISE PIÈCES | LARDONS ÉTAUX

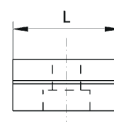
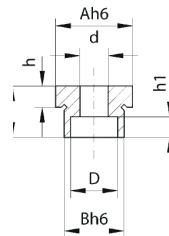

Dim.	Référence	Code	Prix promo € net HT
18 x 22	14-18-22	412235C	69,60
18 x 20	14-18-20	412236C	69,60
18 x 18	14-18-18	412237C	28,20
18 x 16	14-18-16	412238C	69,60
18 x 14	14-18-14	412239C	69,60
14 x 14	14-14-14	412249C	27,31
14 x 18	14-14-18	412250C	69,60
14 x 20	14-14-20	412251C	69,60
14 x 22	14-14-22	412252C	69,60
16 x 12	14-16-12	412253C	35,80
16 x 14	14-16-14	412254C	35,80
16 x 16	14-16-16	412255C	27,31
16 x 18	14-16-18	412256C	35,80
16 x 20	14-16-20	412257C	35,80
16 x 22	14-16-22	412258C	35,80
16 x 24	14-16-24	412259C	69,60
16 x 36	14-16-36	412261C	69,60
18 x 12	14-18-12	412262C	69,60
20 x 22	14-20-22	412267C	74,60
22 x 14	14-22-14	412268C	74,60
22 x 16	14-22-16	412269C	74,60
22 x 18	14-22-18	412270C	74,60
22 x 20	14-22-20	412271C	74,60
22 x 22	14-22-22	412274C	47,20

Conditionnement : 2 pièces

| LES CALES NE SONT RECTIFIÉES QUE SUR DEUX FACES |

ACCESSOIRES DYNAMOMÉTRIQUES

Désignation	Article	Code	Prix tarif € HT
TORX CLiX S-handle dynamometrique 2,5 Nm	SG25	087640	18,33
TORX CLiX T-handle dynamometrique 5,5 Nm	TG55	087641	28,04



Désignation	Article	Code	Prix tarif € HT
Tige Torx T6	T06-R	087651	23,13
Tige Torx T7	T07-R	087652	23,13
Tige Torx T8	T08-R	087653	23,13
Tige Torx T9	T09-R	087654	23,13
Tige Torx T10	T10-R	087655	23,13
Tige Torx T15	T15-R	087656	23,13
Tige Torx T20	T20-R	087657	23,13



Désignation	Article	Code	Prix tarif € HT
Adaptateur de couple Torx 0,4 Nm	DM04	087642	31,74
Adaptateur de couple Torx 0,6 Nm	DM06	087643	31,74
Adaptateur de couple Torx 0,9 Nm	DM09	087644	31,74
Adaptateur de couple Torx 1,0 Nm	DM10	087645	31,74
Adaptateur de couple Torx 1,5 Nm	DM15	087646	31,74
Adaptateur de couple Torx 2,2 Nm	DM22	087647	31,74
Adaptateur de couple Torx 2,5 Nm	DM25	087648	31,74
Adaptateur de couple Torx 3,8 Nm	DM38	087649	31,74
Adaptateur de couple Torx 5,5 Nm	DM55	087650	31,74

TORX
(lot de 6)

TORX PLUS
(lot de 6)

PRISE PIÈCES | KIT TOURNEVIS DINAPLUS

KITDP00000

REF 420536
580 € HT

KIT DINAPLUS
DYNAPLUS KIT
DYNAPLUS KIT
KIT DINAPLUS

ART. 270..

TORX

LAMA INTERCAMBIABILE
INTERCHANGEABLE BLADE
AUSTAUSCHBARES MESSER
LAME INTERCHANGEABLE

ART. 26000

MANICO CACCIAVITE DINAPLUS
DYNAPLUS SCREWDRIVER HANDLE
DYNAPLUS SCHRAUBENDREHER-GRIFF
MANCHE TOURNEVIS DYNAPLUS

ART. 290..

TORX PLUS

LAMA INTERCAMBIABILE
INTERCHANGEABLE BLADE
AUSTAUSCHBARES MESSER
LAME INTERCHANGEABLE

Articles 420537 à 420552

CONTENU DU KIT

- n°1 TORX T6 (Nm0,6)
- n°1 TORX T7 (Nm0,9)
- n°1 TORX T8 (Nm1,2)
- n°1 TORX T9 (Nm1,4)
- n°1 TORX T10 (Nm2,0)
- n°1 TORX T15 (Nm3,0)
- n°1 TORX T20 (Nm5,0)
- n°1 TORX PLUS IP6 (Nm0,6)
- n°1 TORX PLUS IP7 (Nm0,9)
- n°1 TORX PLUS IP8 (Nm1,2)
- n°1 TORX PLUS IP9 (Nm1,4)
- n°1 TORX PLUS IP10 (Nm2,0)
- n°1 TORX PLUS IP15 (Nm3,0)
- n°1 TORX PLUS IP20 (Nm5,0)

ART.	(mm) e	ØD	L
26000	7,3	33,2	131,4
270../290..			

ART.	(mm) Torx Plus	e	L	Nm ^{Max}	TIPO TYPE
27006	6	—	6,3	175	0,6
27007	7	—	6,3	175	0,9
27008	8	—	6,3	175	1,2
27009	9	—	6,3	175	1,4
27010	10	—	6,3	175	2,0
27015	15	—	6,3	175	3,0
27020	20	—	6,3	175	5,0
29006	—	6IP	6,3	175	0,6
29007	—	7IP	6,3	175	0,9
29008	—	8IP	6,3	175	1,2
29009	—	9IP	6,3	175	1,4
29010	—	10IP	6,3	175	2,0
29015	—	15IP	6,3	175	3,0
29020	—	20IP	6,3	175	5,0

LAME TORX
12,98€ HT

LAME TORX PLUS
12,98€ HT



APPAREILS À TARAUDER

BROCHE À CHANGEMENT RAPIDE

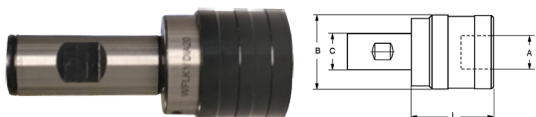

TYPE	CAP.	ADAP.	ØA	ØB	ØC	L	EXTEN.	COMP.	Code	Prix tarif € HT
1 SC	M3-M12	CR1 LC1 RB1	19	36	20	39	7,5	7,5	423185A	147,93

DOUILLES D19 (M3 - M12)

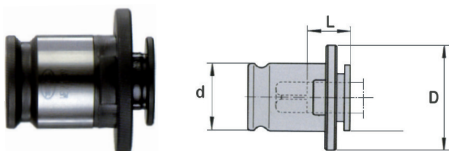

TYPE	Ø TARAUD	ØQ TARAUD	d	D	L	Code	Prix tarif € HT
CR1	M4,5-M10	4-11,2	19	30	7		
TYPE	Ø NOMINAL	DIN 371	DIN 374 / DIN 376				
CR1	M4,5 - 5	3,5 x 2,7	19	30	7	423392A	19,66
CR1	M6	4,5 x 3,4	19	30	7	423393A	19,66
CR1	M8	6 x 4,9	19	30	7	423395A	19,66
CR1	M7	7 x 5,5	19	30	7	423387A	19,66
CR1	M8	8 x 6,2	19	30	7	423388A	19,66
CR1	M9	9 x 7	19	30	7	423389A	19,66
CR1	M10	10 x 8	19	30	7	423382A	28,60



POLISSAGE | ENSEMBLE DE MEULAGE ET POLISSAGE

SMD30LR | EFFICACITÉ, LÉGÈRETÉE ET CONFORT RÉUNIS DANS UN SEUL PRODUIT



- 30 000 TR/MIN
- ANTI-VIBRATIONS
- PINCES DE 6 MM



365975
580,15 €
HT

SPM60LR et SPM80LR | L'ÉVOLUTION D'UN BEST-SELLER

- 60 000 TR/MIN ET 80 000 TR/MIN
- PINCES DE 3 MM

SPM60LR	365974	449,14 €
SPM80LR	365971	410,16 €



DISQUE DE PROTECTION ARROSAGE

Avantages :

- Solution économique pour une vue claire
- Position sur la vitre de protection de la machine librement sélectionnable
- Installation et remplacement très facile
- Utilisation flexible, convient également aux vitres incurvées
- Épaisseur de seulement 0,3 mm
- Aucun montage à vis nécessaire, fixation facile grâce à une couche adhésive spéciale
- Utilisation de la machine possible immédiatement après le montage
- Effet perlé grâce à un revêtement spécial
- Fabriqué en Allemagne

Ø 200 mm
437001 **59,00 €**

Ø 300 mm
437002 **79,00 €**



Plus d'informations

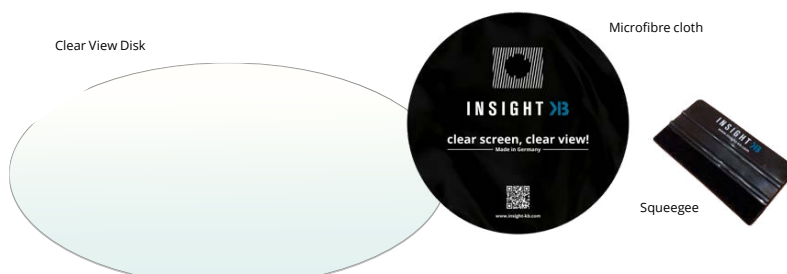



BROSSES EXPANSIBLES ROUGES

Aluminium et acier



Ø du trou	Ø brosse	Longueur	Attach. Ø	Vitesse maxi RPM	Référence	Code	Prix € net HT
3 - 5 mm	1,5 mm	120	3 x 30	18 000	A1215M	190000	45,71
5 - 8 mm	3 mm	120	3 x 30	10 000	A1230M	190001	45,71
8 - 10 mm	5 mm	120	6 x 30	10 000	A1250M	190002	62,29
10 - 16 mm	7 mm	120	6 x 30	10 000	A1270M	190054	89,99
14 - 20 mm	11 mm	120	12 x 30	8 000	A1211M	190055	98,43
5 - 8 mm	3 mm	170	3 x 30	10 000	A1230L	190056	80,28
8 - 10 mm	5 mm	170	6 x 30	10 000	A1250L	190057	102,85
10 - 16 mm	7 mm	170	6 x 30	10 000	A1270L	190058	136,27
14 - 20 mm	11 mm	180	12 x 30	8 000	A1211L	190059	138,28

BROSSES EXPANSIBLES BLEUES

Inox, titane et inconel



Ø du trou	Ø brosse	Longueur	Attach. Ø	Vitesse maxi RPM	Référence	Code	Prix € net HT
5 - 8 mm	3 mm	130	4 x 30	14 000	A3303M	190060	50,26
8 - 10 mm	5 mm	130	6 x 30	14 000	A3305M	190061	68,45
10 - 14 mm	7 mm	130	6 x 30	14 000	A3307M	190062	98,86
14 - 20 mm	11 mm	130	12 x 30	12 000	A3311M	190063	114,99
5 - 8 mm	3 mm	180	4 x 30	12 000	A3303L	190064	88,19
8 - 10 mm	5 mm	180	6 x 30	12 000	A3305L	190065	112,48
10 - 14 mm	7 mm	180	6 x 30	12 000	A3307L	190066	148,81
14 - 20 mm	11 mm	180	12 x 30	10 000	A3311L	190067	161,93

Ebavurage de trous sécants sur centre d'usinage

Utilisation :

- Rotation arrêtée, insérer la brosse dans le trou à ébavurer.
- Démarrer la broche.
- Exécuter des mouvements de broche (environ (300 mm / min).
- Arrêter la rotation avant de sortir la brosse.

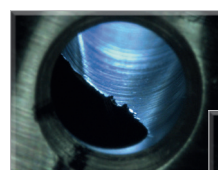
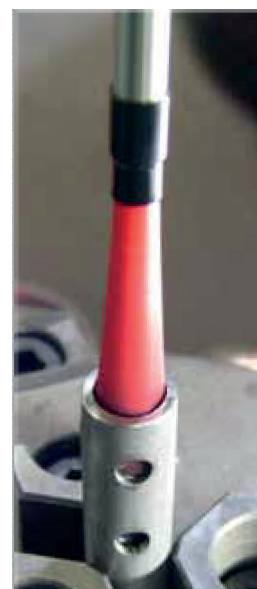
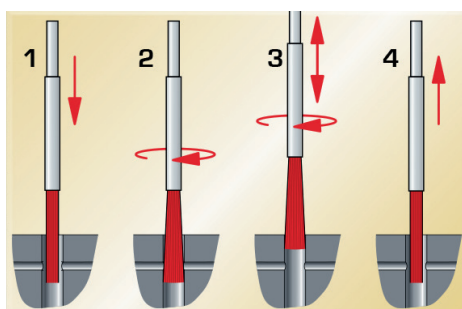

avant

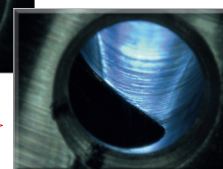





après

BROSSES DE SURFAÇAGE

Brosses

Diamètre de brosse	Longueur des brins	Réf.
Ø 6	30	B13006
Ø 15	50	B13015
Ø 6	30	B11006
Ø 15	50	B11015
Ø 25	75	B11025
Ø 40	75	B11040
Ø 60	75	B11060
Ø 100	75	B11100
Ø 6	30	B21006
Ø 15	50	B21015
Ø 25	75	B21025
Ø 40	75	B21040
Ø 60	75	B21060
Ø 100	75	B21100
Ø 6	30	B32006
Ø 15	50	B32015
Ø 25	75	B32025
Ø 40	75	B32040
Ø 60	75	B32060
Ø 100	75	B32100

Choisir la brosse

Pièce	Brosse
Bavure 0 à 0.05 mm Aluminium, Plastique	
Bavure 0 à 0.1 mm Aluminium, Plastique, Acier	
Bavure 0 à 0.1 mm Aluminium, Acier, Inox	
Bavure 0.1 à 0.2 mm Acier, Inox, Titane, Inconel	

La Brosse et le support sont vendus séparément.

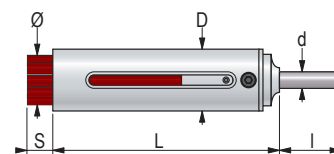
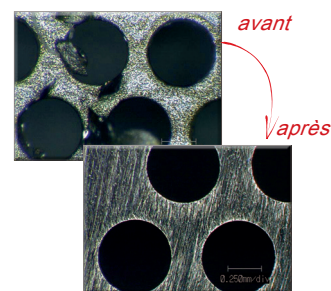
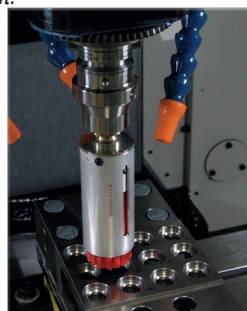

Brosse	Fourreau	Attach.			
Ø Sortie	D	L	d	l	
6	5	10	41	6	29
15	10	18.5	61	6	29
25	15	30	110	8	30
40	15	45	110	10	30
60	15	65	115	12	35
100	15	110	122	16	40

FRAISES DE CHANFREINAGE

Ø	L	L-d	Ø-d	Ø-A	Rpm	mm / min	Ref.	€ tarif ht
0,8	60	5,0	0,48	3,0	43000	1300	XC08A	125,66
1,3	60	8,0	0,78	3,0	27000	800	XC13A	113,44
1,8	60	10,0	1,10	3,0	19500	580	XC18A	100,75
2,3	70	12,5	1,40	3,0	15000	750	XC23A	102,71
2,8	70	15,0	1,70	4,0	12500	1000	XC28A	108,54
3,3	70	17,5	2,00	4,0	10600	1060	XC33A	109,66
3,8	70	20,0	2,40	4,0	9200	1200	XC38A	112,32
4,8	70	25,0	3,00	6,0	7200	1100	XC48A	120,11
5,8	70	30,0	3,50	6,0	6000	900	XC58A	126,56
7,8	100	40,0	4,70	8,0	4500	1350	XC78A	192,59
9,8	120	50,0	5,90	10,0	3600	1080	XC98A	273,32

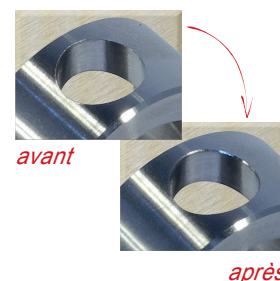
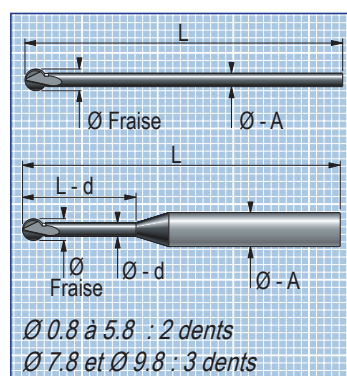

MEULES CÉRAMIQUE D'ÉBAVURAGE

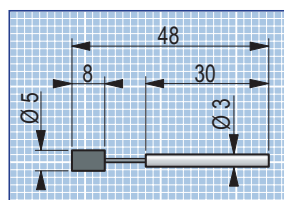

Meule céramique

Un axe en acier à ressort permet la flexibilité de la meule.

Vitesse de rotation : 30 000 tr/min. maxi

Meule	Abrassif	Réf.
Ø 5 x 8 mm	#220	XPM5RF

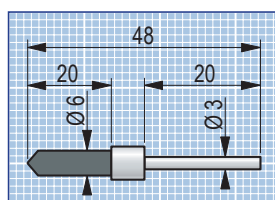
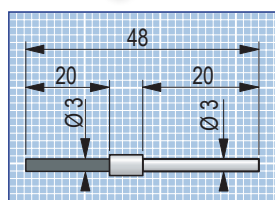

Meules céramiques

Vitesse de rotation : 60 000 tr/min. maxi

Meule	Abrassif	Réf.
Ø 3 x 20 mm	cylindrique #220	XPM3R
Ø 6 x 20 mm	conique #220	XPM6T

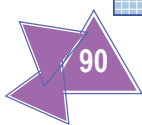

BUDDY

Machine micro-percussion sans fil
Pilotée par smartphone



Ecran OLED

Informations en temps réel

Niveau de batterie, état de la connexion wifi, fichier de marquage en cours...



Autonome en énergie

Batterie Lithium Ion 22V intégrée

- Autonomie suffisante pour une journée de marquage
- Conception spécifique de la batterie pour une meilleure combinaison électronique/batterie/logiciel
- Légèreté, performance et durabilité garanties

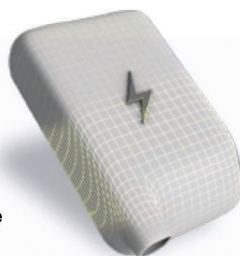

Dock de rangement

- Support de tête avec fixation sur établi
- Rangement pour stylets, ressorts et casquette
- Maintenance : vérification de l'état des ressorts et de l'angle d'affûtage des stylets



5 en 1

- Antidérapant
- Appui magnétique grâce aux aimants
- Marquage sur pièces planes
- Marquage sur petits et grands cylindres grâce aux deux paires de V de centrage
- Aide au positionnement grâce à la casquette

DÉTALONNEUSE

Une solution compacte pour tronçonner des pièces de fabrication cylindrique, détalonner le diamètre des fraises deux tailles, tailler une rainure mais aussi surfacer des faces frontales.

- Mandrin à trois mors Ø 3-30 mm, butée Ø 16 mm
- Bloque broche pour mandrin à trois mors
- Réservoir pour poussière de ponçage et bride pour aspirateur

DONNEES TECHNIQUES

Plage de serrage:	Ø 3 - 30 mm
Moteur:	
Broche affûtage:	250 Watt, 5.000 tr/min
Broche outil :	250 Watt, 150 tr/min
Meule:	Ø 100 x 12,75 x 1,4 mm
Meule à tronçonner:	Ø 110 x 12,75 x 5 mm
Poids net::	28,5 kg
Dimension (L x L x H):	380 x 230 x 220 mm

VERSION DE BASE

- Meule diamant à tronçonner Ø 100 mm, pour carbure de tungstène
- Meule en CBN Ø 100 mm pour HSS
- Meule diamant Ø 100 mm pour carbure de tungstène



PINULE MÉCANIQUE ET MAGNÉTIQUE / RÉGLET INOX



001001000



001010400



001TIN010



001TIN104



Dimensions	Référence	Code	€ promo ht
150X13	R17101	501002	2,60
200X13	R17102	501003	4,20
300X13	R17104	501005	7,40

Description	Article	Diam. queue	Diam. testeur	Code	Prix promo € net HT
PINULE ECO	0010010EP	Ø10	Ø10	592020A	10,00
PINULE ECO	001010AEP	Ø10	Ø10 / Ø4	592006A	10,00
PINULE MECANIQUE	001001000	Ø10	Ø10	592027	39,90
PINULE MECANIQUE	001010400	Ø10	Ø10 / Ø4	592028	39,90
PINULE AMAGNETIQUE TIN	001TIN010	Ø10	Ø10	592026	96,18
PINULE AMAGNETIQUE TIN	001TIN104	Ø10	Ø10 - Ø4	592025	115,60

BUTÉE STANDARD ET MAGNÉTIQUE



003420150



003420001



003420002

Description	Article	Code	Prix tarif € net HT
BUTÉE STANDARD 5D	003420150	472015	133,42
BUTÉE MAGNETIQUE FLEXIMAG	003420001	472030	107,15
BUTÉE MAGNETIQUE EASYMAG	003420002	472031	57,25

DISPOSITIF DE MISE À ZÉRO



Description	Article	Diam. corps	Diam. testeur	Code	Prix promo € net HT
DISPOSITIF DE MISE À ZÉRO - MICRO 100 mm	002400100	Ø54,5	Ø42	592040	280,02
DISPOSITIF DE MISE À ZÉRO MAGNET - MICRO 100 mm	002402100	Ø54,5	Ø42	592041	343,13
DISPOSITIF DE MISE À ZÉRO MAGNET - MICRO 50 mm	002102000	Ø65	Ø47	554051	404,28
ADAPTATEUR H50 POUR H100	002105000	Ø65	Ø47	554052	98,47
DISPOSITIF DE MISE À ZÉRO - MICRO 50 mm	002101000	Ø65	Ø47	554053	263,77



LEVAGE | PORTEUR MAGNÉTIQUE ET AIMANT DE LEVAGE



Capacité	100 KG	300 KG	500 KG	1 000 KG
Code	438074E	438075E	438076E	438077E
Prix	215,51	401,42	572,00	971,89

TÊTES RENVOI D'ANGLE



TÊTES RENVOI D'ANGLE - SÉRIE CP

Ces têtes sont adaptées pour des opérations de perçage, taraudage et alésage. Des adaptations sur mesure sont disponibles pour de nombreuses machines.



PRISE PIÈCES | PLATEAU À DÉPRESSION ET MAGNÉTIQUE



PLATEAU ALUMINIUM À DÉPRESSION À GRILLE AVEC VENTURI



L	I	H	Pas de grille	Référence fournisseur	Code
300	200	30	10 x 10	5001/11/300X200V	438028
400	300	30	10 x 10	5001/11/400X300V	438029
600	400	30	10 x 10	5001/11/600X400V	438030

A partir de
805 €
net ht

CARACTÉRISTIQUES :

- Aluminium massif
 - Planéité et parallélisme : +/-0.01/100 mm
 - Grille pour joint de 4 mm au pas de 10 x 10 mm
 - Nombreuses zones d'aspiration avec bouchons obturateurs
 - Inserts inox M8 au pas de 100 x 100 mm pour bridage mécanique éventuel
 - Butées excentriques sur deux côtés
- Utilisation également possible avec un groupe de vide pour une plus grande force de bridage

LIVRÉ AVEC 4 BRIDES | 2 RÈGLES À RAINURER (LONGUEUR 140MM) | JOINT | TAPIS D'OBTURATION | INDICATEUR DE VIDE ET VENTURI (AIR COMPRIMÉ SAC À 3.5 BARS ET 100L/MM MINIMUM)

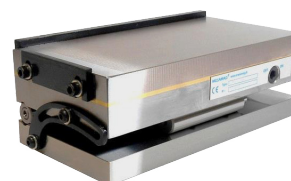

PLATEAU MAGNÉTIQUE

Dimensions	Référence fournisseur	Code
175X100	2001/01/175100	438050
250X130	2001/01/250130	438051
350X150	2001/01/350150	438053
400X150	2001/01/350150	438054

A partir de
630 €
net ht



PLATEAU MAGNÉTIQUE SINUS

Dimensions	Référence fournisseur	Code
175X100	2031/06/175100	438070
150X150	2031/06/150150	438071
250X125	2031/06/250125	438072
300X150	2031/0/300150	438073

A partir de
1 020 €
net ht





VDI B1



VDI B2

Description	Référence	Code	Prix promo € HT	Description	Référence	Code	Prix promo € HT
PO VDI FORME B1 D30X20X40	92B1 302040	621301W	60,64	PO VDI FORME B2 D30X20X40	92B2 302040	622301W	65,05
PO VDI FORME B1 D40X25X44	92B1 402544	621401W	74,97	PO VDI FORME B2 D40X25X44	92B2 402544	622401W	76,07
PO VDI FORME B1 D50X32X55	92B1 503255	621501W	101,43	PO VDI FORME B2 D50X32X55	92B2 503255	622501W	109,15
PO VDI FORME B1 D60X32X60	92B1 603260	621601W	157,66	PO VDI FORME B2 D60X32X60	92B2 603260	622601W	155,45

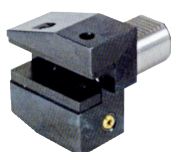

VDI B3



VDI B4

Description	Référence	Code	Prix promo € HT	Description	Référence	Code	Prix promo € HT
PO VDI FORME B3 D30X20X40	92B3 302040	623301W	70,56	PO VDI FORME B4 D30X20X40	92B4 302040	624301W	70,56
PO VDI FORME B3 D40X25X44	92B3 402544	623401W	76,07	PO VDI FORME B4 D40X25X44	92B4 402544	624401W	76,07
PO VDI FORME B3 D50X32X55	92B3 503255	623501W	126,79	PO VDI FORME B4 D50X32X55	92B4 503255	624501W	131,20
PO VDI FORME B3 D60X32X60	92B3 603260	623601W	170,89	PO VDI FORME B4 D60X32X60	92B4 603260	624601W	155,45



VDI B5



VDI B6

Description	Référence	Code	Prix promo € HT	Description	Référence	Code	Prix promo € HT
PO VDI FORME B5 D30X20X40	92B5 302040	625301W	80,48	PO VDI FORME B6 D30X20X40	92B6 302040	626301W	80,48
PO VDI FORME B5 D40X25X44	92B5 402544	625401W	90,41	PO VDI FORME B6 D40X25X44	92B6 402544	626401W	94,82
PO VDI FORME B5 D50X32X55	92B5 503255	625501W	131,20	PO VDI FORME B6 D50X32X55	92B6 503255	626501W	131,20
PO VDI FORME B5 D60X32X60	92B5 603260	625601W	185,22	PO VDI FORME B6 D60X32X60	92B6 603260	626601W	185,22



VDI B7



VDI B8

Description	Référence	Code	Prix promo € HT	Description	Référence	Code	Prix promo € HT
PO VDI FORME B7 D30X20X40	92B7 302040	627301W	83,79	PO VDI FORME B8 D30X20X40	92B8 302040	628301W	83,79
PO VDI FORME B7 D40X25X44	92B7 402544	627401W	97,02	PO VDI FORME B8 D40X25X44	92B8 402544	628401W	97,02
PO VDI FORME B7 D50X32X55	92B7 503255	627501W	148,84	PO VDI FORME B8 D50X32X55	92B8 503255	628501W	148,84
PO VDI FORME B7 D60X32X60	92B7 603260	627601W	202,86	PO VDI FORME B8 D60X32X60	92B8 603260	628601W	202,86





VDI C1

Description	Référence	Code	Prix promo € HT
PO VDI FORME C1 D30X20X70	92C1 302070	631301W	81,59
PO VDI FORME C1 D40X25X85	92C1 402585	631401W	99,23
PO VDI FORME C1 D50X32X100	92C1 5032100	631501W	133,40
PO VDI FORME C1 D60X32X125	92C1 6032125	631601W	200,66



VDI C2

Description	Référence	Code	Prix promo € HT
PO VDI FORME C2 D30X20X70	92C2 302070	632301W	90,41
PO VDI FORME C2 D40X25X85	92C2 402585	632401W	104,74
PO VDI FORME C2 D50X32X100	92C2 5032100	632501W	137,81
PO VDI FORME C2 D60X32X125	92C2 6032125	632601W	209,48



VDI C3

Description	Référence	Code	Prix promo € HT
PO VDI FORME C3 D30X2070	92C3 302070	633301W	86,00
PO VDI FORME C3 D40X25X85	92C3 402585	633401W	108,05
PO VDI FORME C3 D50X32X100	92C3 5032100	633501W	159,86
PO VDI FORME C3 D60X32X125	92C3 6032125	633601W	209,48



VDI C4

Description	Référence	Code	Prix promo € HT
PO VDI FORME C4 D30X20X70	92C4 302070	634301W	86,00
PO VDI FORME C4 D40X25X85	92C4 402585	634401W	108,05
PO VDI FORME C4 D50X32X100	92C4 5032100	634501W	148,84
PO VDI FORME C4 D60X32X125	92C4 6032125	634601W	209,48



VDI E1 Forêt TMAX

Description	Référence	Code	Prix promo € HT
PO VDI FORME E1 D30X16	92E1 3016	649316W	59,54
PO VDI FORME E1 D30X20	92E1 3020	649320W	59,54
PO VDI FORME E1 D30X25	92E1 3025	649325W	59,54
PO VDI FORME E1 D30X32	92E1 3032	649332W	59,54
PO VDI FORME E1 D30X40	92E1 3040	649340W	60,64
PO VDI FORME E1 D40X16	92E1 4016	649416W	78,28
PO VDI FORME E1 D40X20	92E1 4020	649420W	78,28
PO VDI FORME E1 D40X25	92E1 4025	649425W	78,28
PO VDI FORME E1 D40X32	92E1 4032	649432W	78,28
PO VDI FORME E1 D40X40	92E1 4040	649440W	78,28
PO VDI FORME E1 D40X50	92E1 4050	649450W	78,28
PO VDI FORME E1 D50X16	92E1 5016	649516W	88,20
PO VDI FORME E1 D50X20	92E1 5020	649520W	88,20
PO VDI FORME E1 D50X25	92E1 5025	649525W	88,20
PO VDI FORME E1 D50X32	92E1 5032	649532W	88,20
PO VDI FORME E1 D50X40	92E1 5040	649540W	88,20
PO VDI FORME E1 D50X50	92E1 5050	649550W	99,23
PO VDI FORME E1 D60X16	92E1 6016	649616W	143,33
PO VDI FORME E1 D60X20	92E1 6020	649620W	143,33
PO VDI FORME E1 D60X25	92E1 6025	649625W	143,33
PO VDI FORME E1 D60X32	92E1 6032	649632W	143,33
PO VDI FORME E1 D60X40	92E1 6040	649640W	143,33
PO VDI FORME E1 D60X50	92E1 6050	649650W	154,35



VDI E2 Barre d'alésage

Description	Référence	Code	Prix promo € HT
PO VDI FORME E2 D30X6	92E2 3006	650306W	63,95
PO VDI FORME E2 D30X8	92E2 3008	650308W	63,95
PO VDI FORME E2 D30X10	92E2 3010	650310W	63,95
PO VDI FORME E2 D30X12	92E2 3012	650312W	63,95
PO VDI FORME E2 D30X16	92E2 3016	650316W	63,95
PO VDI FORME E2 D30X20	92E2 3020	650320W	63,95
PO VDI FORME E2 D30X25	92E2 3025	650325W	63,95
PO VDI FORME E2 D30X32	92E2 3032	650332W	63,95
PO VDI FORME E2 D30X40	92E2 3040	650340W	63,95
PO VDI FORME E2 D40X6	92E2 4006	650406W	70,56
PO VDI FORME E2 D40X8	92E2 4008	650408W	70,56
PO VDI FORME E2 D40X10	92E2 4010	650410W	70,56
PO VDI FORME E2 D40X12	92E2 4012	650412W	70,56
PO VDI FORME E2 D40X16	92E2 4016	650416W	70,56
PO VDI FORME E2 D40X20	92E2 4020	650420W	70,56
PO VDI FORME E2 D40X25	92E2 4025	650425W	70,56
PO VDI FORME E2 D40X32	92E2 4032	650432W	71,66
PO VDI FORME E2 D40X40	92E2 4040	650440W	79,38
PO VDI FORME E2 D40X50	92E2 4050	650450W	79,38
PO VDI FORME E2 D50X8	92E2 5008	650508W	93,71
PO VDI FORME E2 D50X10	92E2 5010	650510W	93,71
PO VDI FORME E2 D50X12	92E2 5012	650512W	93,71
PO VDI FORME E2 D50X16	92E2 5016	650516W	93,71
PO VDI FORME E2 D50X20	92E2 5020	650520W	93,71
PO VDI FORME E2 D50X25	92E2 5025	650525W	93,71
PO VDI FORME E2 D50X32	92E2 5032	650532W	93,71
PO VDI FORME E2 D50X40	92E2 5040	650540W	93,71
PO VDI FORME E2 D50X50	92E2 5050	650550W	97,02
PO VDI FORME E2 D60X16	92E2 6016	650616W	132,30
PO VDI FORME E2 D60X20	92E2 6020	650620W	132,30
PO VDI FORME E2 D60X25	92E2 6025	650625W	132,30
PO VDI FORME E2 D60X32	92E2 6032	650632W	132,30
PO VDI FORME E2 D60X40	92E2 6040	650640W	137,81
PO VDI FORME E2 D60X50	92E2 6050	650650W	143,33





VDI E4
à pinces



VDI F
Cône morse

Description	Référence	Code	Prix promo € HT	Description	Référence	Code	Prix promo € HT
PO VDI FORME E4 D30 PINCE ER16	92E4 3016	683014W	102,53	PO VDI F D30 MK1	92F30 MK1	660301W	70,56
PO VDI FORME E4 D30 PINCE ER25	92E4 3025	683016W	102,53	PO VDI F D30 MK2	92F30 MK2	660302W	70,56
PO VDI FORME E4 D30 PINCE ER32	92E4 3032	683020W	102,53	PO VDI F D30 MK3	92F30 MK3	660303W	70,56
PO VDI FORME E4 D30 PINCE ER40	92E4 3040	683026W	102,53	PO VDI F D40 MK1	92F40 MK1	660401W	77,18
PO VDI FORME E4 D40 PINCE ER25	92E4 4025	684016W	102,53	PO VDI F D40 MK2	92F40 MK2	660402W	77,18
PO VDI FORME E4 D40 PINCE ER32	92E4 4032	684020W	102,53	PO VDI F D40 MK3	92F40 MK3	660403W	77,18
PO VDI FORME E4 D40 PINCE ER40	92E4 4040	684026W	102,53	PO VDI F D40 MK4	92F40 MK4	660404W	86,00
PO VDI FORME E4 D50 PINCE ER25	92E4 5025	685016W	132,30	PO VDI F D50 MK2	92F50 MK2	660502W	98,12
PO VDI FORME E4 D50 PINCE ER32	92E4 5032	685020W	132,30	PO VDI F D50 MK3	92F50 MK3	660503W	98,12
PO VDI FORME E4 D50 PINCE ER40	92E4 5040	685026W	132,30	PO VDI F D50 MK4	92F50 MK4	660504W	109,15
PO VDI FORME E4 D60 PINCE ER32	92E4 6032	686020W	167,58	PO VDI F D50 MK5	92F50 MK5	660505W	148,84
PO VDI FORME E4 D60 PINCE ER40	92E4 6040	686026W	176,40	PO VDI F D60 MK2	92F60 MK2	660602W	141,12
				PO VDI F D60 MK3	92F60 MK3	660603W	141,12
				PO VDI F D60 MK4	92F60 MK4	660604W	149,94
				PO VDI F D60 MK5	92F60 MK5	660605W	159,86



VDI GML



VDI AR
Lame à tronçonner

Description	Référence	Code	Prix promo € HT	Description	Référence	Code	Prix promo € HT
MAND TARAUD CHANG RAPIDE	92GML V30GR1	690001W	218,30	PO VDI30 A DTE PORTE LAME 26mm	92AR 3026	640001W	297,68
MAND TARAUD CHANG RAPIDE	92GML V30GR2	690002W	266,81	PO VDI30 A DTE PORTE LAME 32mm	92AR 3032	640002W	339,57
MAND TARAUD CHANG RAPIDE	92GML V40GR1	690003W	231,53	PO VDI40 A DTE PORTE LAME 26mm	92AR 4026	640003W	334,06
MAND TARAUD CHANG RAPIDE	92GML V40GR2	690004W	266,81	PO VDI40 A DTE PORTE LAME 32mm	92AR 4032	640004W	334,06
MAND TARAUD CHANG RAPIDE	92GML V40GR3	690005W	351,70	PO VDI50 A DTE PORTE LAME 26mm	92AR 5026	640005W	351,70
MAND TARAUD CHANG RAPIDE	92GML V50GR3	690006W	363,83	PO VDI50 A DTE PORTE LAME 32mm	92AR 5032	640006W	351,70
MAND TARAUD CHANG RAPIDE	92GML V50GR1	690008W	242,55	PO VDI60 A DTE PORTE LAME 32mm	92AR 6032	640007W	606,38
MAND TARAUD CHANG RAPIDE	92GML V50GR2	690009W	278,93				



VDI ARU
Lame à tronçonner



VDI AL
Lame à tronçonner

Description	Référence	Code	Prix promo € HT	Description	Référence	Code	Prix promo € HT
PO VDI30 A DTE PORTE LAME 26mm	92ARU 3026	640010W	296,57	PO VDI30 A GCHE PORTE LAME 26mm	92AL 3026	640020W	297,68
PO VDI30 A DTE PORTE LAME 32mm	92ARU 3032	640011W	345,08	PO VDI30 A GCHE PORTE LAME 32mm	92AL 3032	640021W	339,57
PO VDI40 A DTE PORTE LAME 26mm	92ARU 4026	640012W	327,44	PO VDI40 A GCHE PORTE LAME 26mm	92AL 4026	640022W	334,06
PO VDI40 A DTE PORTE LAME 32mm	92ARU 4032	640013W	345,08	PO VDI40 A GCHE PORTE LAME 32mm	92AL 4032	640023W	334,06
PO VDI50 A DTE PORTE LAME 26mm	92ARU 5026	640014W	357,21				
PO VDI50 A DTE PORTE LAME 32mm	92ARU 5032	640015W	375,95				



VDI SG
Tire-barre

Description	Référence	Code	Prix promo € HT
TIRE BARRE VDI30 CAP 6 110	92SG 30	641001	738,68
TIRE BARRE VDI40 CAP 6 110	92SG 40	641002	815,85
TIRE BARRE VDI50 CAP 6 110	92SG 50	641003	1047,38

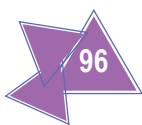



TYPE TOLÉRANCE				GO / NOGO 6H		GO 6G		NOGO 6G	
M	MF	P	Index	S3 302161		Y3 412162		Y3 4221862	
				Code	Prix promo	Code	Prix promo	Code	Prix promo
M	2	0,4	0020	-	66,49	555090	108,50	555151	108,50
M	2,5	0,45	0025	-	85,93	555091	82,50	555152	82,50
M	3	0,5	0030	555040	59,00	555093	66,00	555154	66,00
M	3,5	0,6	0035	555041	59,50	555094	66,00	555155	66,00
M	4	0,7	0040	045062	55,50	555095	66,00	555156	66,00
M	5	0,8	0050	045063	53,50	555097	66,00	555158	66,00
M	6	1	0060	045064	51,50	555098	66,00	555159	66,00
M	7	1	0070	555046	52,50	555099	72,50	555160	72,50
M	8	1,25	0080	045065	56,50	555100	66,00	555161	66,00
M	8	1	0083	555048	63,50	555101	72,50	555162	72,50
M	9	1,25	0090						
M	10	1,5	0100	045066	64,50	555103	72,50	555164	72,50
M	10	1	0103	555051	66,50	555104	82,50	555165	82,50
M	10	1,25	0104	555052	84,00	555105	92,17	555166	92,17
M	12	1,75	0120	045067	68,00	555106	89,00	555167	89,00
M	12	1,5	0125	555054	84,00	555107	92,17	555168	92,17
M	14	2	0140	555055	71,00	555108	89,00	555169	89,00
M	14	1,5	0145	555056	87,50	555109	95,67	555170	95,67
M	16	2	0160	045068	76,50	555110	82,00	555171	82,00
M	16	1,5	0165	555058	87,50	555111	95,67	555172	95,67
M	18	2,5	01800	555059	81,50	555112	93,00	555173	93,00
M	18	1,5	0185	555060	215,83	555113	122,50	555174	122,50
M	20	2,5	0200	555061	86,50	555114	103,00	555175	103,00
M	20	1,5	0205	555062	103,83	555115	122,50	555176	122,50
M	22	2,5	0220	555063	90,00	555116	110,50	555177	110,50
M	22	1,5	0225	555064	103,83	555117	122,50	555178	122,50
M	24	3	0240	555065	103,00	555118	118,00	555179	118,00
M	24	1,5	0245	555066	103,83	555119	122,50	555180	122,50
M	25	1,5	0255	-	90,80	555120	143,50	-	93,29
M	27	3	0270	555067	113,00	555121	130,50	555181	130,50
M	30	3,5	0300	555068	125,00	555123	145,00	555183	145,00
M	30	1,5	0305	-	108,51	555124	177,33	-	107,34
M	33	3,5	0330	555069	135,00	555125	157,50	555184	157,50
M	36	4	0360	555070	152,50	555126	172,00	555185	172,00
M	39	4	0390	555071	165,00	555127	188,50	555186	188,50
M	42	4,5	0420			555129	203,50	555188	203,50
M	45	4,5	0450			555130	216,00	555189	216,00
M	48	5	0480			555131	229,00	555190	229,00
M	52	5	0520			555133	239,00	555191	239,00

Désignation	Articles	Code	Prix promo € net HT
Coffret de 7 tampons lisses H7	8AALSATZ312	555202	199,00



TYPE TOLÉRANCE			GO / NOGO		GO A		NOGO A	
G	1"/P	Index	S3 302180		Y3 412180		Y3 422180	
			Code	Prix	Code	Prix	Code	Prix
G 1/8"	28	3123	555039	82,00	555143	99,00		81,74
G 1/4"	19	3127	555038	88,00	555142	115,00		92,86
G 3/8"	19	3129	555076	90,50	555137	105,00	555193	105,00
G 1/2"	14	3131	555077	102,00	555138	119,50	555194	119,50
G 5/8"	14	3133		-	555139	-	555195	-
G 3/4"	14	3135	555078	116,00	555140	136,00	555196	136,00



TYPE TOLÉRANCE			GO/NOGO H7				
Ø nom.	Index	S3 100111		Ø nom.	Index	S3 100111	
		Code	Prix			Code	Prix
3	0030	555001	30,00	26	0260	555015	35,00
4	0040	555002	30,50	28	0280	555016	36,00
5	0050	555003	26,50	30	0300	555017	37,50
6	0060	555004	22,50	32	0320	555018	50,00
8	0080	555005	24,50	34	0340	555020	53,00
10	0100	555006	24,50	35	0350	555021	53,50
12	0120	555007	26,50	36	0360	555022	54,50
14	0140	555008	33,50	37	0370	555023	55,50
16	0160	555009	28,00	38	0380	555024	56,50
18	0180	555010	28,00	40	0400	555025	59,50
20	0200	555011	32,50	42	0420	555026	65,00
22	0220	555012	32,50	45	0450	555027	68,50
24	0240	555013	32,50	47	0470	555028	68,00
25	0250	555014	35,00	50	0500	555029	72,00

Désignation	Articles	Prix promo € net HT
Certificat de contrôle tampons doubles Ø 1 à 150 mm	89000000001	15,00
Certificat de contrôle GLD Ø 1 à 40 mm	99000000001	23,00
Certificat de contrôle GLD > Ø 40 à 200 mm	99000000004	35,00
Calibrage DakkS des tampons limites Ø 1 - 40 mm	89000000050	45,00
Calibrage DakkS Go et NoGo Ø 1 à 40 mm	89000000053	45,00
Calibrage DakkS du filetage GLD >Ø 3 à 40 mm	99000000051	45,00
Calibrage DakkS Filets-Go/NoGo >Ø 3 à 40 mm	99000000055	45,00

Franco de port départ agences - 150 €

Forfait expédition usine - 20 €

Pour toute expédition directe les frais de port seront facturés.

Les articles lourds sont indiqués par un logo poids.  Pour ces articles, **des frais de transport supplémentaires sont appliqués.**

M	Pas [mm]	Diamètre max du noyau (tol. 6H) [mm]	Diamètre de perçage [mm]
1	0,25	0,785*	0,75
1,1	0,25	0,885*	0,85
1,2	0,25	0,985*	0,95
1,4	0,30	1,142*	1,10
1,6	0,35	1,321	1,25
1,7***	0,35	1,421	1,35
1,8	0,35	1,521	1,45
2	0,40	1,679	1,60
2,2	0,45	1,838	1,75
2,3***	0,40	1,938	1,90
2,5	0,45	2,138	2,05
2,6***	0,45	2,238	2,10
3	0,50	2,599	2,50
3,5	0,60	3,010	2,90
4	0,70	3,422	3,30
4,5	0,75	3,878	3,70
5	0,80	4,334	4,20
6	1,00	5,153	5,00
7	1,00	6,153	6,00
8	1,25	6,912	6,80
9	1,25	7,912	7,80
10	1,50	8,676	8,50
11	1,50	9,676	9,50
12	1,75	10,441	10,20
14	2,00	12,210	12,00
16	2,00	14,210	14,00
18	2,50	15,744	15,50
20	2,50	17,744	17,50
22	2,50	19,744	19,50
24	3,00	21,252	21,00
27	3,00	24,252	24,00
30	3,50	26,771	26,50
33	3,50	29,771	29,50
36	4,00	32,270	32,00
39	4,00	35,270	35,00
42	4,50	37,799	37,50
45	4,50	40,799	40,50
48	5,00	43,297	43,00
52	5,00	47,297	47,00
56	5,50	50,796	50,50
60***	5,50	54,796	54,50
64***	6,00	58,305	58,00
68***	6,00	62,305	62,00

G	Pas TPI	Diamètre max du noyau (tol. 6H) [mm]	Diamètre de perçage [mm]
G 1/8"	28	8,848	8,80
1/4"	19	11,890	11,80
3/8"	19	15,395	15,25
1/2"	14	19,172	19,00
5/8"	14	21,128	21,00
3/4"	14	24,658	24,50
7/8"	14	28,418	28,25
1"	11	30,931	30,75
11/8"	11	35,579	35,50
11/4"	11	39,592	39,50
13/8"	11	42,005	41,90
11/2"	11	45,485	45,25
13/4"	11	51,428	51,00
2"	11	57,296	57,00
21/4"	11	63,392	63,30
23/8"	11	67,080	67,00
21/2"	11	72,866	72,80
23/4"	11	79,216	79,10
3"	11	85,566	85,50
31/4"	11	91,662	91,50
31/2"	11	98,012	98,00
33/4"	11	104,362	104,00
4"	11	110,712	110,50



UNC	Pas TPI	Diamètre max du noyau (tol. 6H) [mm]	Diamètre de perçage [mm]
Nr. 1	64	1,582	1,55
Nr. 2	56	1,872	1,85
Nr. 3	48	2,146	2,10
Nr. 4	40	2,385	2,35
Nr. 5	40	2,697	2,65
Nr. 6	32	2,896	2,85
Nr. 8	32	3,528	3,50
Nr. 10	24	3,950	3,90
Nr. 12	24	4,590	4,50
1/4"	20	5,250	5,10
5/16"	18	6,680	6,60
3/8"	16	8,082	8,00
7/16"	14	9,441	9,40
1/2"	13	10,881	10,80
9/16"	12	12,301	12,20
5/8"	11	13,693	13,50
3/4"	10	16,624	16,50
7/8"	9	19,520	19,50
1"	8	22,344	22,25
11/8"	7	25,082	25,00
11/4"	7	28,258	28,00
13/8"	6	30,851	30,75
11/2"	6	34,026	34,00
13/4"	5	39,560	39,50
2"	4,5	45,367	45,00

UNF	Pas TPI	Diamètre max du noyau (tol. 6H) [mm]	Diamètre de perçage [mm]
Nr. 0	80	1,306	1,25
Nr. 1	72	1,613	1,55
Nr. 2	64	1,913	1,85
Nr. 3	56	2,197	2,15
Nr. 4	48	2,459	2,40
Nr. 5	44	2,741	2,70
Nr. 6	40	3,012	2,95
Nr. 8	36	3,597	3,50
Nr. 10	32	4,168	4,10
Nr. 12	28	4,717	4,60
1/4"	28	5,563	5,50
5/16"	24	6,995	6,90
3/8"	24	8,565	8,50
7/16"	20	9,947	9,90
1/2"	20	11,524	11,50
9/16"	18	12,969	12,90
5/8"	18	14,554	14,50
3/4"	16	17,546	17,50
7/8"	14	20,493	20,40
1"	12	23,363	23,25
11/8"	12	26,538	26,50
11/4"	12	29,713	29,50
13/8"	12	32,888	32,75
11/2"	12	36,063	36,00

**Rendez-vous
sur notre site internet !**





Techmo - Orléans

ECOPARK Orléans N°28
1695 rue de la Grand Cour
45760 MARIGNY-LES-USAGES
02 38 61 48 10
commercial.techmo@techmo.fr



Techmo - Toulouse

18 chemin de la violette
31240 L'UNION
05 61 61 34 35
magasin.toulouse@techmo.fr



Satech - Le Mans

ACTIPARC N°6
150 route du parc
72700 SPAY
02 43 40 05 05
magasin@satech.fr



Techmo Satech

techmo.fr | satech.fr

PRIX PROMOTIONNELS NET HT - OFFRE VALABLE DANS LA LIMITE DES STOCKS DISPONIBLES - 31-12-2026*

* Techmo Satech se réserve le droit de modifier les prix promotionnels en fonction des éventuels changements de prix de nos partenaires.